

Your Inspection Report



105 Scenic Mill Way, Suite 115
Toronto, ON M2L 1T1



PREPARED FOR:
ROGER TRAVASSOS

INSPECTION DATE:
Monday, June 17, 2024

PREPARED BY:
Sheila Corman, RHI



Carson, Dunlop & Associates Ltd.
120 Carlton Street, Suite 407
Toronto, ON M5A 4K2

416-964-9415
www.carsondunlop.com
inspection@carsondunlop.com

Excellence in home inspection



June 17, 2024

Dear Roger Travassos,

RE: Report No. 88910
105 Scenic Mill Way, 115
Toronto, ON
M2L 1T1

Thank you for choosing us to perform your home inspection. We hope the experience met your expectations.

The enclosed report includes an Overview tab which summarizes key findings, and the report body. The Good Advice tab provides helpful tips for looking after your home; the Reference tab includes a 500-page Reference Library; and the Appendix tab includes valuable added benefits. You can navigate by clicking the tabs at the top of each page.

Please contact us with any questions about the report or the home itself anytime, for as long as you own your home. Our telephone and e-mail consulting services are available at no cost to you. Please watch for your follow-up e-mail. We hope you will complete our short client questionnaire.

Thanks again for choosing Carson Dunlop.

Sincerely,

Sheila Corman, RHI
on behalf of
Carson, Dunlop & Associates Ltd.

Carson, Dunlop & Associates Ltd.
120 Carlton Street, Suite 407
Toronto, ON M5A 4K2
416-964-9415
www.carsondunlop.com
inspection@carsondunlop.com

OVERVIEW

105 Scenic Mill Way, Toronto, ON June 17, 2024

Report No. 88910

www.carsondunlop.com

OVERVIEW

ROOFING

EXTERIOR

STRUCTURE

ELECTRICAL

HEATING

COOLING

INSULATION

PLUMBING

INTERIOR

OUR ADVICE

APPENDIX

REFERENCE

This Overview lists some of the significant report items if any were identified. Please read the entire report before making any decisions about the home; do not rely solely on the Overview.

FOR THE BUYER

There are two elements to a home inspection - the inspection itself and the report. This report is helpful, but the inspection is equally important. You need both elements to make an informed decision. Call us at 416-964-9415 to book a Buyers Review with the inspector. Our fee is \$260. Without a Buyers Review, our obligation and liability are limited to the seller.

When you move into the home you may find some issues not identified in the report. That is to be expected for a few reasons, such as furniture and storage that has been removed, changes to the property conditions, etc. Therefore, we suggest you allow roughly 1% of the value of the home annually for maintenance and repair.

Roofing

RECOMMENDATIONS \ General

Condition: • The roof inspection was restricted by limited access.

The age and condition of the roof covering were not determined.

Task: Further evaluation by a specialist.

Time: As soon as practical

Exterior

WALLS \ Masonry (brick, stone) and concrete

Condition: • Masonry deterioration

Suspect water damage to the bricks is caused by ponding and overflow at the cap flashing at the roof here. No interior damage was noted. A roofer should determine the condition of the roof in general and the flashings here to determine the source of the water infiltration.

Implication(s): Weakened structure | Chance of structural movement

Location: Right (looking from street)

Task: Further Evaluation/Repair

Time: As soon as practical

Cost: Depends on work needed, \$3,000 - \$6,000 for masonry repair

Heating

FURNACE \ Life expectancy

Condition: • Near end of life expectancy

Although the furnace is close to the end of its life, continue to use and maintain the unit until it fails. Be prepared to replace the furnace at any time.

Implication(s): Equipment failure | No heat for building

Location: Furnace room

OVERVIEW

105 Scenic Mill Way, Toronto, ON June 17, 2024

Report No. 88910

www.carsondunlop.com

OVERVIEW

ROOFING

EXTERIOR

STRUCTURE

ELECTRICAL

HEATING

COOLING

INSULATION

PLUMBING

INTERIOR

OUR ADVICE

APPENDIX

REFERENCE

Task: Replace
Time: When necessary
Cost: \$3,500-\$7,000

Plumbing

WATER HEATER \ Life expectancy

Condition: • Past life expectancy

Be prepared to replace at any time.

Implication(s): No hot water

Task: Replace

Time: Soon

Cost: \$1,000 - \$3,000 or continue to rent

Here are a few thoughts to help you stay warm, safe and dry in your home.

All homes require regular maintenance and periodic updates. Maintenance programs help keep homes safe, comfortable and efficient. Roofs, furnaces and air conditioners for example, wear out and have to be replaced. Good maintenance extends the life of these house systems. Refer to Our Advice tab for more details regarding maintenance of your home.

Water is the biggest enemy of homes, whether from leaks through the roof, walls or foundation, or from plumbing inside the home. Preventative maintenance and quick response to water problems are important to minimize damage, costs and help prevent mould.

Environmental consultants can help with issues like mould, indoor air quality and asbestos. If you need help in these areas, we can connect you with professionals.

All recommendations in the report should be addressed by qualified specialists. Our ballpark costs and time frames are provided as a courtesy and should be confirmed with quotes from specialists. Minor costs in the report are typically under \$1,000.

END OF OVERVIEW

Description

Flat roofing material:

- [Synthetic rubber](#)



Synthetic rubber

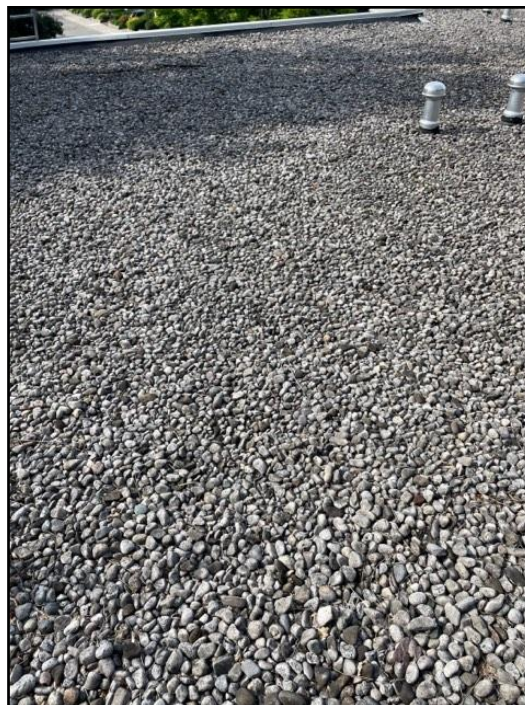

Synthetic rubber

Observations and Recommendations

RECOMMENDATIONS \ General

Condition: • The roof inspection was restricted by limited access.

The age and condition of the roof covering were not determined.

Task: Further evaluation by a specialist.

Time: As soon as practical

Inspection Methods and Limitations

Inspection limited/prevented by: • Gravel covering membrane

Inspection performed: • By walking on roof

- OVERVIEW
 - ROOFING
 - EXTERIOR**
 - STRUCTURE
 - ELECTRICAL
 - HEATING
 - COOLING
 - INSULATION
 - PLUMBING
 - INTERIOR
- OUR ADVICE
 - APPENDIX
 - REFERENCE

Description

Wall surfaces and trim: • [Brick](#)

Observations and Recommendations

WALLS \ Masonry (brick, stone) and concrete

Condition: • [Cracked](#)

Implication(s): Chance of water entering building | Weakened structure | Chance of movement

Location: Front Garage

Task: Monitor / Improve

Time: As necessary

Cost: Minor



Cracked

Condition: • Masonry deterioration

Suspect water damage to the bricks is caused by ponding and overflow at the cap flashing at the roof here. No interior damage was noted. A roofer should determine the condition of the roof in general and the flashings here to determine the source of the water infiltration.

Implication(s): Weakened structure | Chance of structural movement

Location: Right (looking from street)

Task: Further Evaluation/Repair

Time: As soon as practical

Cost: Depends on work needed, \$3,000 - \$6,000 for masonry repair

EXTERIOR

105 Scenic Mill Way, Toronto, ON June 17, 2024

Report No. 88910

www.carsondunlop.com

OVERVIEW

ROOFING

EXTERIOR

STRUCTURE

ELECTRICAL

HEATING

COOLING

INSULATION

PLUMBING

INTERIOR

OUR ADVICE

APPENDIX

REFERENCE



Masonry deterioration



Masonry deterioration



Masonry deterioration

LANDSCAPING \ General notes

Condition: • Shrubs/Trees - too close to building (trimming needed)

Task: Trim

EXTERIOR

105 Scenic Mill Way, Toronto, ON June 17, 2024

Report No. 88910

www.carsondunlop.com

OVERVIEW	ROOFING	EXTERIOR	STRUCTURE	ELECTRICAL	HEATING	COOLING	INSULATION	PLUMBING	INTERIOR
OUR ADVICE	APPENDIX	REFERENCE							

Time: Regular maintenance

Cost: Minor

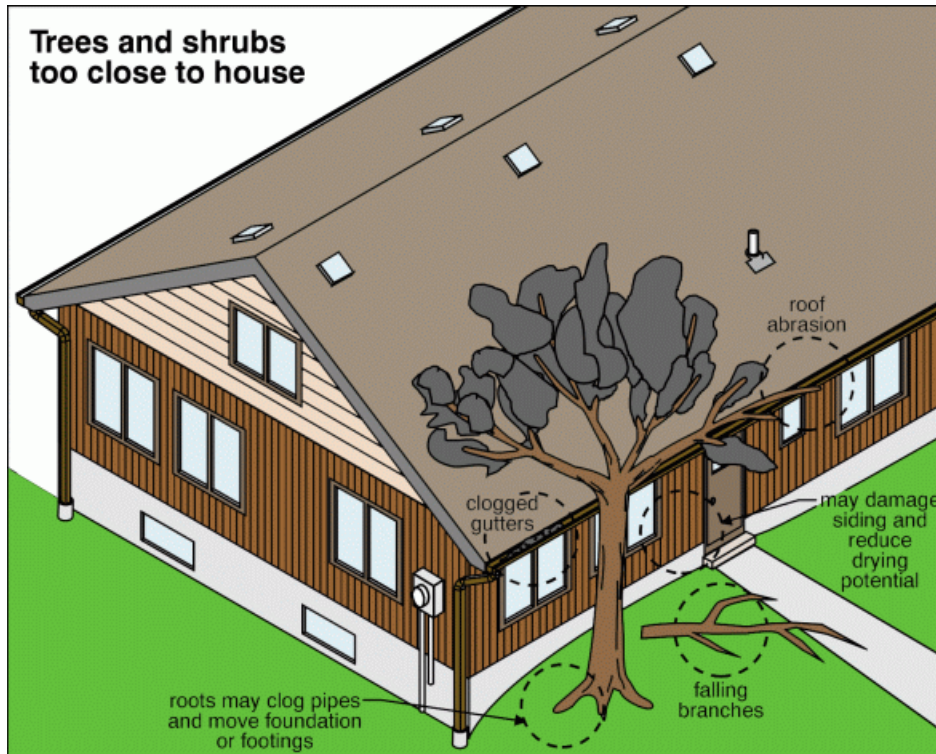

Shrubs- too close to building...



Trees - too close to building...

EXTERIOR

105 Scenic Mill Way, Toronto, ON June 17, 2024

Report No. 88910

www.carsondunlop.com

OVERVIEW

ROOFING

EXTERIOR

STRUCTURE

ELECTRICAL

HEATING

COOLING

INSULATION

PLUMBING

INTERIOR

OUR ADVICE

APPENDIX

REFERENCE

LANDSCAPING \ Lot grading

Condition: • The ground around some parts of the home does not slope to drain water away from the foundation.

Implication(s): Risk of water leaking into the basement or crawlspace.

Location: Various

Task: Improve grading so the ground slopes down at least 1 inch per foot for the first 6 feet away from the home. Note: Less slope is needed on hard surfaces like driveways

Time: If necessary



neutral grade



neutral grade

GARAGE \ Vehicle doors

Condition: • Rot

The bottoms of the garage vehicle doors appear to have suffered previous water damage. They have since been wood-filled and painted over. Monitor and maintain regularly and replace when necessary.

Implication(s): Material deterioration

Location: Front

Task: Repair / Replace

Time: Regular maintenance



Rot



Rot

Inspection Methods and Limitations

Inspection limited/prevented by:

- Inaccessible wall
At rear.

Inspection limited/prevented by: • No access to garage. The doors were locked and no key was available.

Exterior inspected from: • Ground level

OVERVIEW

ROOFING

EXTERIOR

STRUCTURE

ELECTRICAL

HEATING

COOLING

INSULATION

PLUMBING

INTERIOR

OUR ADVICE

APPENDIX

REFERENCE

Description

General: • The structure has performed well, with no evidence of significant movement.

Configuration: • [Basement](#)

Foundation material: • [Poured concrete](#)

Floor construction: • [Joists](#)

Exterior wall construction: • [Wood frame / Brick veneer](#) • [Masonry](#)

Roof and ceiling framing: • Not visible

Observations and Recommendations

RECOMMENDATIONS \ General

Condition: • Most foundation walls and masonry walls have small cracks due to minor shrinkage, settlement or shifting. These will not be individually noted, unless leakage or building movement is noted.

FLOORS \ Concrete slabs

Condition: • Concrete basement, crawlspace and garage floors are not typically part of the structure. Almost all basement, crawlspace and garage concrete floors have minor shrinkage and settlement cracks.

Inspection Methods and Limitations

Attic/roof space: • Flat roof space - no access

Description

Service size: • [100 Amps \(240 Volts\)](#)

Main disconnect/service box type and location: • [Breakers - basement](#)

Distribution panel type and location:

- [Breakers - basement](#)

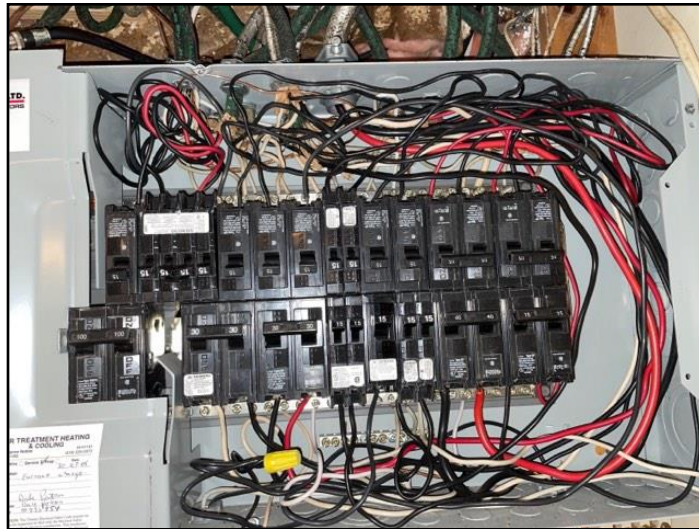

Breakers - basement

Auxiliary panel (subpanel) type and location:

- [Breakers - basement](#)

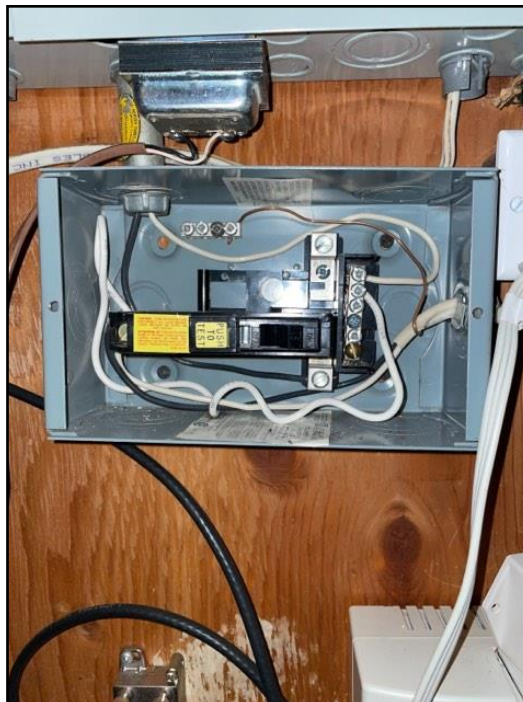

Breakers - basement

OVERVIEW	ROOFING	EXTERIOR	STRUCTURE	ELECTRICAL	HEATING	COOLING	INSULATION	PLUMBING	INTERIOR
OUR ADVICE	APPENDIX	REFERENCE							

Distribution wire (conductor) material and type: • [Copper - non-metallic sheathed](#) • [Copper - metallic sheathed](#)
Circuit interrupters: Ground Fault (GFCI) & Arc Fault (AFCI): • [GFCIs present](#) • No AFCI

Observations and Recommendations

DISTRIBUTION SYSTEM \ Outlets (receptacles)

Condition: • [No GFCI/GFI \(Ground Fault Circuit Interrupter\)](#)

Implication(s): Electric shock

Location: Laundry area and Kitchen sink

Task: Provide

Cost: Minor

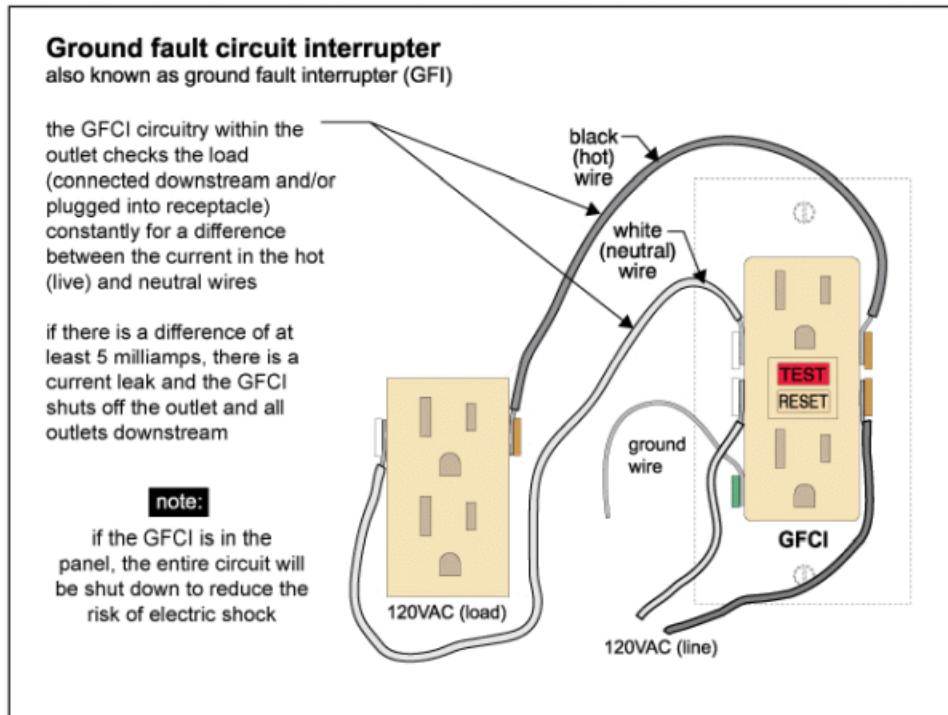

Condition: • [Reversed polarity](#)

Implication(s): Electric shock

Location: Basement Furnace Room

Task: Correct

Cost: Minor

Reversed polarity

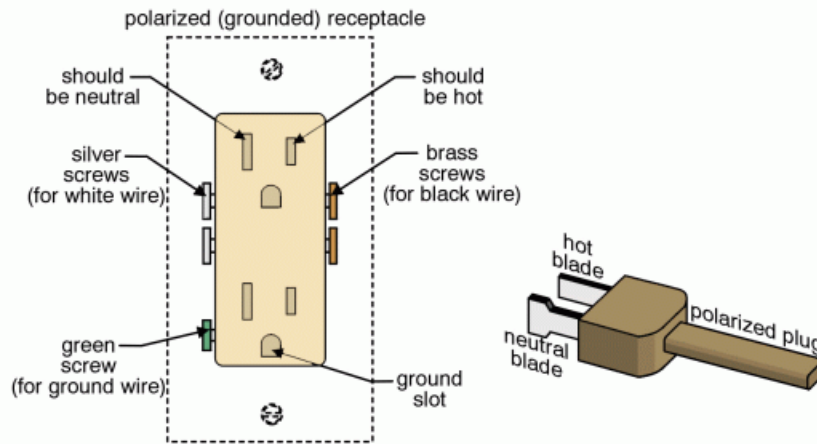

when the polarity is reversed, the wide receptacle slot is (incorrectly) hot and the narrow slot is neutral - this is not uncommon when people forget that the black wire should be attached to the receptacle's brass screws

Inspection Methods and Limitations

Inspection limited/prevented by: • Main disconnect cover not removed - unsafe to do so.

Description

Heating system type: • [Furnace](#)

Fuel/energy source: • [Gas](#)

Approximate capacity: • [90,000 BTU/hr](#)

Efficiency: • [Mid-efficiency](#)

Approximate age: • [18 years](#)

Typical life expectancy: • Furnace (conventional or mid-efficiency) 18 to 25 years

Fireplace/stove: • None

Chimney/vent: • [Metal](#)

Humidifier: • Not present

Observations and Recommendations

RECOMMENDATIONS \ General

Condition: • It is common to feel the airflow stronger at some registers, depending on the length of the ductwork and the number of turns required to get there. Different preferences and seasons often necessitate different setups (balancing). A service agreement that covers parts and labour (for heating and cooling equipment) is typically advised.

Location: Throughout

Task: Monitor / improve

FURNACE \ Life expectancy

Condition: • Near end of life expectancy

Although the furnace is close to the end of its life, continue to use and maintain the unit until it fails. Be prepared to replace the furnace at any time.

Implication(s): Equipment failure | No heat for building

Location: Furnace room

Task: Replace

Time: When necessary

Cost: \$3,500-\$7,000

HEATING

105 Scenic Mill Way, Toronto, ON June 17, 2024

Report No. 88910

www.carsondunlop.com

OVERVIEW

ROOFING

EXTERIOR

STRUCTURE

ELECTRICAL

HEATING

COOLING

INSULATION

PLUMBING

INTERIOR

OUR ADVICE

APPENDIX

REFERENCE



Near end of life expectancy

COOLING & HEAT PUMP

105 Scenic Mill Way, Toronto, ON June 17, 2024

Report No. 88910

www.carsondunlop.com

OVERVIEW

ROOFING

EXTERIOR

STRUCTURE

ELECTRICAL

HEATING

COOLING

INSULATION

PLUMBING

INTERIOR

OUR ADVICE

APPENDIX

REFERENCE

Description

Air conditioning type:

- [Air cooled](#)



Air cooled

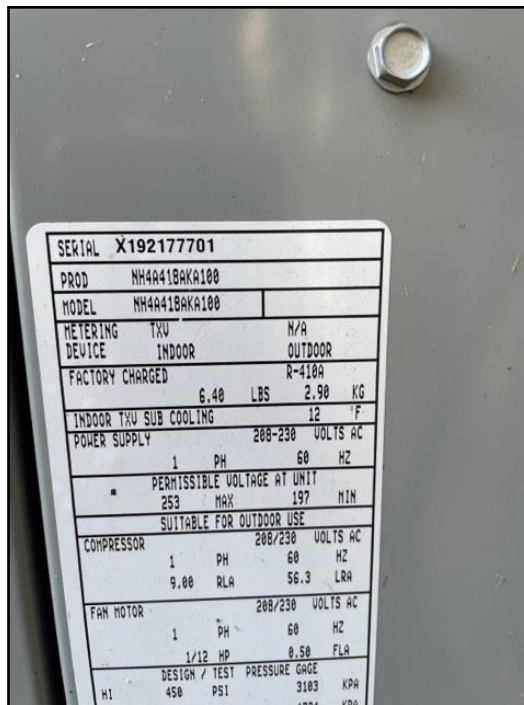

Air cooled

Cooling capacity: • [18,000 BTU/hr](#)

Compressor approximate age: • 5 years

Typical life expectancy: • 10 to 15 years

Observations and Recommendations

RECOMMENDATIONS \ Overview

Condition: • An annual maintenance program is recommended for heating and cooling systems to optimize safety, efficiency, comfort and durability.

INSULATION AND VENTILATION

105 Scenic Mill Way, Toronto, ON June 17, 2024

Report No. 88910

www.carsondunlop.com

OVERVIEW

ROOFING

EXTERIOR

STRUCTURE

ELECTRICAL

HEATING

COOLING

INSULATION

PLUMBING

INTERIOR

OUR ADVICE

APPENDIX

REFERENCE

Description

- Attic/roof insulation material:** • Not visible
- Attic/roof insulation amount/value:** • Not determined
- Attic/roof air/vapor barrier:** • [Not visible](#)

Observations and Recommendations

RECOMMENDATIONS \ General

- Condition:** • No insulation recommendations are offered as a result of this inspection.

Inspection Methods and Limitations

- Inspection limited/prevented by lack of access to:** • Roof space
- Inspection limited/prevented by lack of access to:** • Wall space - access not gained.
- Roof ventilation system performance:** • Not evaluated

OVERVIEW

ROOFING

EXTERIOR

STRUCTURE

ELECTRICAL

HEATING

COOLING

INSULATION

PLUMBING

INTERIOR

OUR ADVICE

APPENDIX

REFERENCE

Description

Service piping into building: • [Copper](#)

Supply piping in building: • [Copper](#)

Main water shut off valve at the: • Basement • Furnace area

Water heater type: • [Conventional](#)

Water heater fuel/energy source: • [Gas](#)

Water heater tank capacity: • 151 liters

Water heater approximate age: • 16 years

Water heater typical life expectancy: • 10 to 15 years

Waste and vent piping in building: • [Plastic](#)

Pumps: • None

Floor drain location: • Furnace area

Backwater valve: • None noted

Observations and Recommendations

RECOMMENDATIONS \ General

Condition: • Many plumbing fixtures may be expected to last 15 years or more, although faucets are often replaced every 10 years.

WATER HEATER \ Life expectancy

Condition: • Past life expectancy

Be prepared to replace at any time.

Implication(s): No hot water

Task: Replace

Time: Soon

Cost: \$1,000 - \$3,000 or continue to rent



Past life expectancy

WASTE PLUMBING \ Drain piping - performance

Condition: • The main sewer line to the street cannot be inspected during a home inspection. A video scan dramatically reduces the risk of expensive and unhealthy sewer back-ups.

Implication(s): Possible sewer back-up into home due to roots, obstructions or collapsed drain pipe.

Task: Provide after possession of the home.

Cost: \$300

Old clay pipe sewer issues - shift, collapse, roots, silt

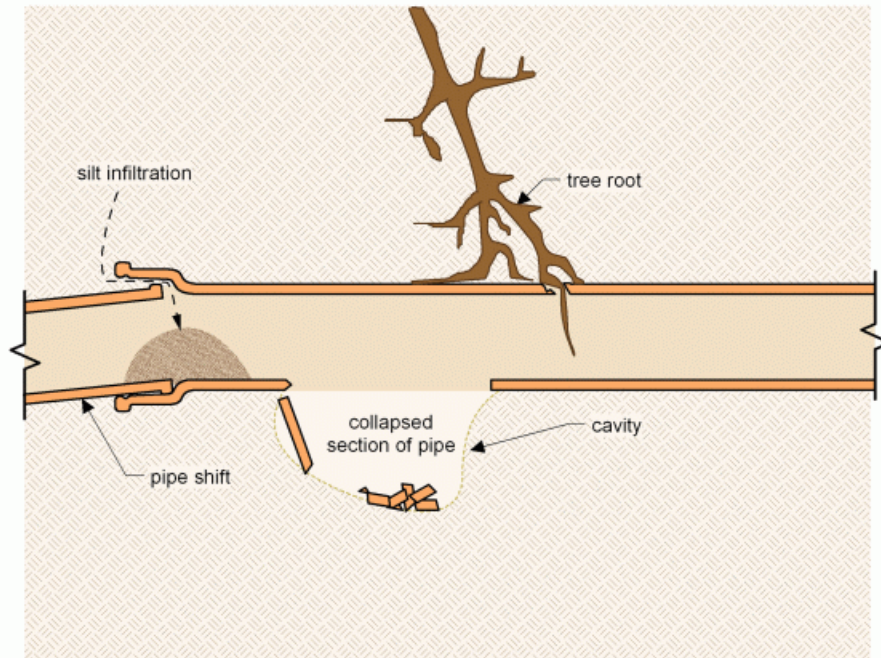

Condition: • [Leak](#)

Implication(s): Sewage entering the building

Location: Furnace Area

Task: Repair

Time: As soon as practical

Cost: Minor



Leak

WASTE PLUMBING \ Backwater valve

Condition: • None noted

Adding a backwater valve to the main drain line is an improvement you may consider to help protect your home against sewer backups. Some municipalities provide rebates or financial assistance for installing these devices. Some insurance companies offer premium discounts or other benefits for homeowners with backwater valves. The cost is typically \$2,000 to \$4,000, with \$2,500 being a common number. Once installed, they should be inspected twice annually.

Implication(s): Sewage entering the building

Location: Basement

Task: Provide

Time: Discretionary

Cost: \$2,000 - \$4,000

- OVERVIEW
 - ROOFING
 - EXTERIOR
 - STRUCTURE
 - ELECTRICAL
 - HEATING
 - COOLING
 - INSULATION
 - PLUMBING**
 - INTERIOR
- OUR ADVICE
 - APPENDIX
 - REFERENCE

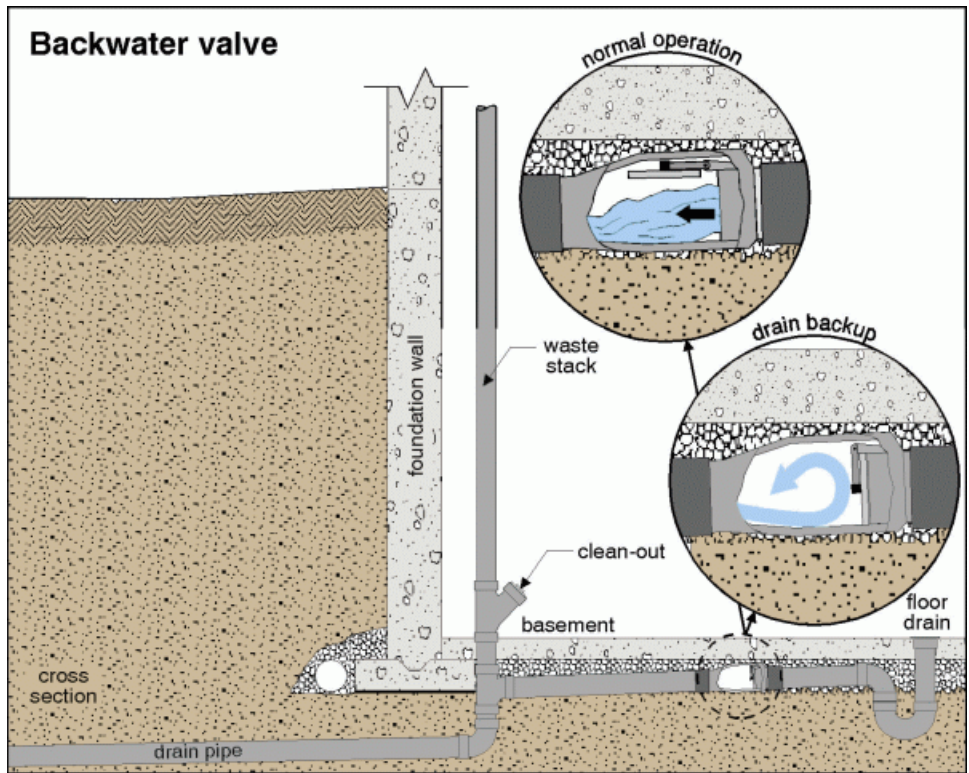

Inspection Methods and Limitations

- Fixtures not tested/not in service:** • Fixtures in powder room (suspected to be behind locked door off of main foyer).
- Items excluded from a building inspection:** • Tub/sink overflows

Description

General: • Interior finishes are in good repair overall. • The newer windows help improve comfort and energy efficiency.

Observations and Recommendations

BASEMENT \ Leakage

Condition: • Almost every basement (and crawlspace) leaks under the right conditions. Based on a one-time visit, it's impossible to know how often or severe leaks may be. While we look for evidence of past leakage during our consultation, this is often not a good indicator of current conditions. Exterior conditions such as poorly performing gutters and downspouts, and ground sloping down toward the house often cause basement leakage problems. Please read Section 10.0 in the Interior section of the Home Reference Book before taking any action. You can find this in the Reference tab at the end of the report.

To summarize, wet basement issues can be addressed in 4 steps:

1. First, ensure gutters and downspouts carry roof run-off away from the home. (relatively low cost)
2. If problems persist, slope the ground (including walks, patios and driveways) to direct water away from the home. (Low cost if done by homeowner. Higher cost if done by contractor or if driveways, patios and expensive landscaping are disturbed.)
3. If the problem is not resolved and the foundation is poured concrete, seal any leaking cracks and form-tie holes from the inside. (A typical cost is \$300 to \$600 per crack or hole.)
4. As a last resort, dampproof the exterior of the foundation, provide a drainage membrane and add/repair perimeter drainage tile. (High cost)

Inspection Methods and Limitations

Inspection limited/prevented by: • No access to (powder room?)



door locked to powder room

Percent of foundation not visible: • 85%

Description

OUR ADVICE FOR LOOKING AFTER YOUR HOME: • Home maintenance is an important responsibility. It protects your investment, extends life expectancy and helps avoid significant expenses. This document is an integral part of the report, and will help you avoid many common problems and reduce costs.

Priority Maintenance and Home Set-Up: • The Home Set-Up and Maintenance chapter in the Home Reference Book provides important information regarding things that are done once when moving in, as well as regular maintenance activities.

Please be sure to follow these maintenance guidelines. The Home Reference Book is included under the REFERENCE tab in this report.

Basement/Crawlspace Leakage: • Basement water leakage is the most common problem with homes. Almost every basement and crawlspace leaks under the right conditions. Good maintenance of exterior grading, gutters and downspouts is critically important.

For more details, please refer to Section 10 of the Interior chapter of the Home Reference Book, which is in the REFERENCE tab in this report.

Roof - Annual Maintenance: • It is important to set up an annual inspection and tune-up program to minimize the risk of leakage and maximize the life of the roof. Roof leaks may occur at any time and are most often at penetrations or changes in material. A leak does not necessarily mean the roof needs to be replaced.

Roof coverings are disposable and have to be replaced from time to time. Asphalt shingles, for example, last roughly 15 years.

Exterior - Annual Maintenance: • Annual inspection of the exterior is important to ensure weather-tightness and durability of exterior components. Grading around the home should slope to drain water away from the foundation to help keep the basement dry.

Painting and caulking should be well maintained. Particular attention should be paid to horizontal surfaces where water may collect.

Joints, intersections, penetrations and other places where water may enter the building assembly should be checked and maintained regularly.

Garage Door Operators: • The auto reverse mechanism on your garage door opener should be tested monthly. The door should also reverse when it meets reasonable resistance, or if the 'photo eye' beam is broken.

Electrical System - Label the Panel: • Each circuit in the electrical panel should be labelled to indicate what it controls. This improves both safety and convenience. Where the panel is already labelled, the labelling should be verified as correct. Do not rely on existing labeling.

Ground Fault Circuit Interrupters and Arc Fault Circuit Interrupters: • These should be tested monthly using the test buttons on the receptacles or on the breakers in the electrical panel.

Heating and Cooling System - Annual Maintenance: • Set up an annual maintenance agreement that covers parts and labour for all heating and cooling equipment. This includes gas fireplaces and heaters, as well as furnaces, boilers and air conditioners. Include humidifiers and electronic air cleaners in the service agreement. Arrange the first visit as soon as possible after taking possession.

Check filters for furnaces and air conditioners monthly and change or clean as needed. Duct systems have to be balanced to maximize comfort and efficiency, and to minimize operating costs. Adjust the balancing for heating and cooling seasons, respectively.

For hot water systems, balancing should be done by a specialist to due to the risk of leakage at radiator valves. These valves are not operated during a home inspection. • Check filters for furnaces and air conditioners monthly and change or clean as needed. Duct systems have to be balanced to maximize comfort and efficiency, and to minimize operating costs. Adjust the balancing for heating and cooling seasons, respectively. • For hot water systems, balancing should be done by a specialist due to the risk of leakage at radiator valves. These valves are not operated during a home inspection.

Bathtub and Shower Maintenance: • Caulking and grout in bathtubs and showers should be checked every 6 months, and improved as necessary to prevent leakage and water damage behind walls and below floors.

Water Heaters: • All water heaters should be flushed by a specialist every year to maximize performance and life expectancy. This is even more critical on tankless water heaters.

Washing Machine Hoses: • We suggest braided steel hoses rather than rubber hoses for connecting washing machines to supply piping in the home. A ruptured hose can result in serious water damage in a short time, especially if the laundry area is in or above a finished part of the home.

Clothes Dryer Vents: • We recommend that vents for clothes dryers discharge outside the home. The vent material should be smooth walled (not corrugated) metal, and the run should be as short and straight as practical. This reduces energy consumption and cost, as well as drying time for clothes. It also minimizes the risk of a lint fire inside the vent.

Lint filters in the dryer should be cleaned every time the dryer is used. There is a secondary lint trap in many condominiums. These should be cleaned regularly. There may also a duct fan controlled by a wall switch. The fan should be ON whenever the dryer is used.

Dryer ducts should be inspected annually and cleaned as necessary to help reduce the risk of a fire, improve energy efficiency and reduce drying times.

Fireplace and Wood Stove Maintenance: • Wood burning appliances and chimneys should be inspected and cleaned before you use them, and annually thereafter. We recommend that specialists with a WETT (Wood Energy Technology Transfer, Inc.) designation perform this work. Many insurance companies require a WETT inspection for a property with a wood burning device.

Smoke and Carbon Monoxide (CO) Detectors/Alarms: • Smoke detectors are required at every floor level of every home, including basements and crawlspaces. Even if these are present when you move into the home, we recommend replacing the detectors. We strongly recommend photoelectric smoke detectors rather than ionization type detectors. Carbon monoxide detectors should be provided adjacent to all sleeping areas.

These devices are not tested during a home inspection. Detectors should be tested every 6 months, and replaced every 10 years. Batteries for smoke and carbon monoxide detectors should be replaced annually. If unsure of the age of a smoke detector, it should be replaced.

Backwater Valve: • A backwater valve protects your home from a backup of the municipal sewer system. The valve may be equipped with an alarm to notify you of a backup. Please note: if the valve is closed due to a municipal sewer backup, you cannot use the plumbing fixtures in the home. The waste water is unable to leave the building and will back up through floor drains and the lowest plumbing fixtures.

• The valve should be inspected and cleaned as necessary at least twice a year.

Sump Pump: • A sump pump collects storm water below the basement floor and discharges it safely to the exterior to prevent flooding. The discharge point should be at least 6 feet (2 m) away from the home. Best installations include backup power for the sump pump, so it will work in the event of a power outage. A high water alarm in the sump pump will notify you if the pump fails. Some installations include a backup pump.

The sump and pump should be inspected and tested four times a year.

For condominium owners: • Condominium owners - Maintenance and Repairs: There are two types of repairs that may be performed in a condo - repairs to an individual condo unit and repairs to common elements. Common elements are set out in the Condominium Declaration and will differ from one building to another. If repairs must be made inside your unit, you are responsible for making the repairs at your own expense. You are also responsible for the ongoing maintenance of your unit. The condominium corporation's board of directors is responsible for maintenance and repair of the common elements. Exclusive-use common elements, such as parking spaces or balconies are generally maintained by the condominium board.

Be Ready for Emergencies: Be sure you know where to shut off the water. Some condos have more than one shut off, and others need a special tool (key) to turn off water. Label each circuit on the electrical panel, and make sure you should know how to turn off the power. Keep a fire extinguisher suitable for grease fires near the kitchen.

Property Manager and Concierge/Security: Keep the contact information for these folks handy (perhaps on your phone) wherever you are. • Lint filters in the dryer should be cleaned every time the dryer is used. There is a secondary lint trap in many condominiums. These should be cleaned regularly. There may also a duct fan controlled by a wall switch. The fan should be ON whenever the dryer is used.

END OF REPORT

OVERVIEW	ROOFING	EXTERIOR	STRUCTURE	ELECTRICAL	HEATING	COOLING	INSULATION	PLUMBING	INTERIOR
OUR ADVICE	APPENDIX	REFERENCE							



As a Carson Dunlop client, you are entitled to many useful discounts and perks from some of our home service partners.



Our gift to you - a **\$100 Jiffy gift card***

Jiffy connects homeowners to trusted Pros, delivering instant appointments at pre-set, fair rates. To redeem your gift card, create an account at jiffyondemand.com or via mobile app. Use code **CARSON91472** on your first booking, or enter your code in your Jiffy Profile. ***Where available**

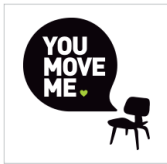

\$100 Gift Card from You Move Me

<https://www.youmoveme.com/ca/save-100-off-moving-services>



\$70 gift card from 1-800-GOT-JUNK?

Carson Dunlop clients receive a \$70 gift card for junk removal services.



David Slack Insurance Brokers

Specializing in older homes, David provides superior, knowledgeable advice and service in a timely manner. [\(800\) 971-1363](tel:8009711363) or email david@davidslackinsurance.com

OVERVIEW	ROOFING	EXTERIOR	STRUCTURE	ELECTRICAL	HEATING	COOLING	INSULATION	PLUMBING	INTERIOR
OUR ADVICE	APPENDIX	REFERENCE							



THREE STEPS TO COST-EFFECTIVE HOME FLOOD PROTECTION

Complete these 3 steps to reduce your risk of flooding and lower the cost of cleanup if flooding occurs. For items listed under step 3 check with your municipality about any permit requirements and the availability of flood protection subsidies. **Applicable only in homes with basements*

Step 1: Maintain What You've Got at Least Twice per Year

Do-it-Yourself for \$0

Remove debris from nearest storm drain or ditch & culvert

Clean out eaves troughs

Check for leaks in plumbing, fixtures and appliances

Test your sump pump*

Clean out your backwater valve

Step 2: Complete Simple Upgrades

Do-it-Yourself for Under \$250

Install window well covers (where fire escape requirements permit)*

Extend downspouts and sump discharge pipes at least 2m from foundation

Store valuables and hazardous materials in watertight containers & secure fuel tanks

Remove obstructions to floor drain

Install and maintain flood alarms

Step 3: Complete More Complex Upgrades

Work with a Contractor for Over \$250

Install window wells that sit 10-15cm above ground and upgrade to water resistant windows*

Disconnect downspouts, cap foundation drains and extend downspouts to direct water at least 2m from foundation

Correct grading to direct water at least 2m away from foundation

Install backwater valve

Install backup sump pump and battery*

Note: Not all actions will be applicable to each home. Completing these steps does not guarantee the prevention of flooding.

- OVERVIEW
- ROOFING
- EXTERIOR
- STRUCTURE
- ELECTRICAL
- HEATING
- COOLING
- INSULATION
- PLUMBING
- INTERIOR
- OUR ADVICE
- APPENDIX
- REFERENCE



Basement Flood Protection Checklist

Take these steps to reduce your risk of basement flooding and reduce the cost of cleaning up after a flood. Remember to check with your municipality about the availability of basement flood protection subsidies. Check with your insurer about discounts for taking action to reduce flood risk.

1. Maintain Your Home’s Flood Protection Features at Least Twice Per Year

SPRING FALL

- Remove debris from nearest storm drain
- Clean out eaves troughs
- Test sump pump(s) and backup power source
- Clean out backwater valve
- Maintain plumbing, appliances and fixtures
- Test flood alarms

2. Keep Water Out of Your Basement

- Correct grading to direct water at least 2m away from your foundation
- Extend downspouts and sump discharge pipes to direct water at least 2m away from your foundation or to the nearest drainage swale
- Install window well covers
- Install window wells that are 10-15cm above the ground and are sealed at the foundation
- Install water-resistant basement windows
- Install a backwater valve (work with a plumber and get required permits)

3. Prepare to Remove Any Water from Your Basement as Quickly as Possible

- Remove obstructions to the basement floor drain
- Install a back-up sump pump and power source

4. Protect Personal Belongings in Your Basement

- Store valuables in watertight containers or remove
- Store hazardous materials (paints, chemicals) in watertight containers or remove
- Raise electronics off the floor
- Select removable area rugs and furnishings that have wooden or metal legs

Note: Not all actions will be applicable to each home. Completing these steps does not guarantee the prevention of basement flooding.



For Additional Resources Visit:
www.HomeFloodProtect.ca



THIS CONTRACT LIMITS THE LIABILITY OF THE HOME INSPECTOR AND THE HOME INSPECTION COMPANY.

PLEASE READ CAREFULLY BEFORE ACCEPTING.

The term "Inspector" or "we" as used in this document means, collectively, the home inspector and Carson, Dunlop & Associates Ltd. ("CD"), the home inspection company. The home inspection ("Inspection") is performed in accordance with the Standards of Practice of the Canadian Association of Home and Property Inspectors (the "Standards"). We recommend that you review the Standards before agreeing to the Inspection. To access the Standards, click [CAHPI 2023 National Standards of Practice](#).

1) PURPOSE AND LIMITATIONS

The Inspector's report (the "Report") is an opinion of the present condition of the property based on a visual examination of the readily accessible features of the building.

An Inspector is a generalist, rather than a specialist. The Inspection is a non-invasive performance review, rather than a design review. The Inspector does not perform calculations to determine whether mechanical, electrical, and structural systems, for example, are properly sized. The Inspector will not perform any engineering, architectural, plumbing or electrical services or assessments that require an occupational license.

The Inspector may report on deficiencies or conditions that are normally outside the scope of the Inspection, but this is done as a courtesy and does not change the scope of the Inspection.

If the purpose or limitations are not clear, we encourage you to contact the Inspector to discuss the agreement before accepting and before the inspection.

2) THE INSPECTION IS NOT TECHNICALLY EXHAUSTIVE

The Inspection is a sampling exercise and is not technically exhaustive. While looking for major issues, we typically come across some smaller issues. These may be included in the Report as a courtesy, but not all issues will be identified. Cosmetic and other non-critical items are not part of the Inspection. Establishing the significance of an issue may be beyond the scope of the Inspection. Further evaluation by a specialist may be required at additional cost.

A Technical Audit is a more in-depth, technically exhaustive inspection of the home that provides more information than an Inspection. We have both services available. By accepting and signing this Agreement, you acknowledge that you have chosen an Inspection instead of a Technical Audit.

If you are concerned about any conditions noted in the Report, we strongly recommend that you consult a qualified specialist for a more detailed analysis.

3) THE INSPECTION IS AN OPINION OF THE PRESENT CONDITION OF THE VISIBLE COMPONENTS

The Report is based on the visually observable conditions on the date and time of the Inspection. Not all deficiencies may be apparent due to weather conditions, inoperable systems, inaccessibility, etc. The Inspector cannot predict future conditions.

RLS:00475320.1

An Inspection does NOT include or identify defects that are hidden behind walls, floors, ceilings, storage, furniture, etc. This includes inaccessible elements such as, but not limited to, wiring, heating, cooling, structure, plumbing and insulation. Inspectors do not remove wall coverings (including wallpaper), lift flooring (including carpet), or move storage or furniture.

Intermittent problems may not be visible on an Inspection because they only happen under certain circumstances. For example, the Inspector may not discover leaks that occur only during certain weather conditions.

Representative sampling is used for components where there are several similar items. This includes, but is not limited to, roofing, siding, masonry, caulking, windows, interior doors, electrical wiring, receptacles, switches, ducts and pipes, insulation and air/vapor barriers, and floor, wall, and ceiling surfaces.

4) THIS IS NOT A CODE-COMPLIANCE INSPECTION

Inspectors do NOT determine whether the property complies with past or present building codes, electrical codes, fuel codes, fire codes, regulations, laws, by-laws, ordinances, or other regulatory requirements. Codes change regularly, and most homes do not comply with current codes.

5) THE INSPECTION DOES NOT INCLUDE HAZARDOUS MATERIALS

The Inspection does NOT address building materials that are suspected of posing a risk to health such as phenol-formaldehyde and urea-formaldehyde based insulation, fiberglass insulation and vermiculite insulation. Inspectors do NOT identify asbestos in roofing, siding, wall, ceiling or floor finishes, insulation, fireproofing, etc. Inspectors do NOT look for lead or other toxic metals. Environmental consultants should be consulted independently, at additional cost, should concerns exist.

The Inspection does not address environmental hazards such as the past use of insecticides, fungicides, herbicides, pesticides or termite treatments.

6) THE INSPECTION DOES NOT ADDRESS MOULD AND THE AIR QUALITY IN A BUILDING

The Inspection does NOT address irritants, pollutants, contaminants, or toxic materials in or around the building. This includes, for example, spores, fungus, mould, or mildew.

You should note that whenever there is water damage, there is a possibility that mould or mildew may be present, unseen behind a wall, floor, or ceiling.

If anyone in your home suffers from allergies or heightened sensitivity to quality of air, or if there are water penetration issues noted in the Report, we strongly recommend that you consult a qualified environmental consultant who can test for toxic materials, mould and allergens at an additional cost.

7) THE INSPECTION DOES NOT INCLUDE BURIED TANKS

Inspectors do NOT look for, and are not responsible for identifying, fuel oil, septic or gasoline tanks that may be buried on the property. If there are fuel oil or other storage tanks on the property, you may be responsible for their removal and the safe disposal of any contaminated soil. If you suspect there is a buried tank, we strongly recommend that you retain a qualified Environmental Consultant, at an additional cost, to investigate further.

RLS:00475320.1

8) CANCELLATION FEE

If the Inspection is cancelled within 24 hours of the appointment time, a cancellation fee of 50% of the fee will apply.

9) THERMAL IMAGING (If included with this Inspection)

The use of a thermal imager by your Inspector (which you can purchase for an extra cost) is for the purpose of screening for potential water issues. While the use of this equipment improves the odds of detecting a moisture issue, it is not a guarantee, as numerous conditions can mask the thermal signature of moisture. Thermal imaging will not detect all moisture issues behind walls, ceilings, or furniture. Additionally, water leakage is often intermittent, and cannot be detected when not present.

10) MOULD ASSESSMENT (If included with this Inspection)

The services provided in this optional assessment (which you can purchase for an extra cost) include a visual inspection for signs of water intrusion and mould growth. Moisture readings will be collected. Two indoor air samples and one outdoor reference sample will be collected. Should visible mould growth be identified, one surface sample will be collected. The results of the sample and investigation will be summarized in a written Report.

The mould assessment will not be able to detect or identify all mould that may be present in the home, including that which is hidden behind walls, floors, ceilings, storage, or furniture.

11) REPORT IS FOR OUR CLIENT ONLY

The Report is for the exclusive use of the client named herein and their real estate agent if applicable and will not be released to others without the client's consent. No use of, or reliance on, the Report or any information contained in the Report by any other party is intended. The client agrees that the Report will not be shared or distributed to third parties, except to prospective buyers of the property in the case of a pre-listing inspection.

NOTE: If you do not want your real estate agent to receive a copy of the report, please let us know at 416-964-9415 or inspection@carsondunlop.com.

12) NOT A GUARANTEE, WARRANTY, OR INSURANCE POLICY

The Inspection and Report are NOT a guarantee, warranty, or an insurance policy on the condition, future use, operability, habitability or suitability of the home or its components.

Given the limitations to the visual Inspection, the Inspector is neither responsible nor liable for the non-discovery of any patent or latent defects, or other conditions which may occur or may become evident after the date and time of the Inspection.

13) TIME TO INVESTIGATE

The Inspector will have no liability for any claim or complaint if conditions have been disturbed, altered, repaired, replaced, or otherwise changed before the Inspector has had reasonable time to investigate.

RLS:00475320.1

14) LIMIT OF LIABILITY/INDEMNITY

By executing this Agreement, you expressly agree that the TOTAL CUMULATIVE LIABILITY OF THE INSPECTOR AND CD FOR ANY DAMAGES ARISING OUT OF ANY ACTS OR OMISSIONS WITH RESPECT TO THE INSPECTOR'S INSPECTION AND REPORT, FOR ANY CAUSE OF ACTION WHATSOEVER, WHETHER IN CONTRACT OR TORT (INCLUDING NEGLIGENCE), IS LIMITED TO A REFUND OF THE FEES THAT YOU HAVE BEEN CHARGED FOR THIS INSPECTION OR \$1,000, WHICHEVER IS GREATER.

You agree to indemnify and hold the Inspector, CD and its directors, officers, employees, agents, affiliates and consultants harmless from and against any and all claims, demands, liabilities, judgements, losses and expenses, including legal fees and expenses, brought against or involving the Inspector that relate to or arise out of the Inspection or the Report whether indirect, consequential, punitive or special losses, damages, or loss of profits.

You agree that any claim for negligence, breach of contract or otherwise relating to the Inspection or the Report will be made in writing and reported to the Inspector within 10 business days of discovery. Further, you agree to allow the Inspector the opportunity to re-inspect the claimed discrepancy, except for an emergency condition, before anyone repairs, replaces, alters or modifies the claimed discrepancy. You understand and agree that any failure to notify the Inspector as stated above shall constitute a waiver of all claims that you may have against the Inspector.

This limit of liability clause may be altered at the discretion and agreement of the Inspector and the client, but any agreement must be in writing and appended to this Agreement.

15) TIME PERIOD

You acknowledge and agree that the timeframe for commencement of legal proceedings by you against the Inspector for damages suffered by you as a result of alleged errors, omissions, breaches of contract and/or negligence by the Inspector shall not be later than one (1) year from the date of the Inspection.

16) PRIVACY/USE OF PERSONAL INFORMATION

The Inspector confirms their commitment to collect, store and use your personal information only in accordance with the terms of the CD's Privacy Policy. A copy of this document may be accessed at <https://www.carsondunlop.com/privacy/>. You are strongly encouraged to review this document before signing this Agreement and providing your personal information to the Inspector and CD.

The Inspector may collect data which will primarily consist of information relating to the visual inspection conducted, but may also consist of other data relating to the property inspected, client and/or client representative personal and contact information, and demographic data. The Inspector may use the collected data to perform analysis, improve business processes, improve the CD inspection experience, and obtain feedback from clients and client representatives. The Inspector confirms that collection and use of this data and certain personal information is for the following purposes:

- To provide you with information regarding CD products, services and benefits that you request or other products, services and benefits which may interest you; and

- To identify trends and patterns related to the use of goods and services in the home inspection and construction industries and to provide information on those trends and patterns to our customers and others.

In addition, the Inspector may provide collected data to third-party service providers ("TPSPs") to offer value-added services to clients, as described in this Agreement. The Inspector may provide aggregated collected data, individual collected data and/or collected personal information (including name, property address, email addresses, phone numbers, appliance information and property data) to third parties. Other than interaction with TPSPs, aggregated data, individual collected data and/or collected personal information, the Inspector will not sell or rent the collected data to anyone, or share the collected data with any third party except as necessary to fulfill client requests.

By executing this Agreement, you confirm that you expressly consent to the collection and use of data by the Inspector as described herein and in CD's Privacy Policy.

If you DO NOT consent to the Inspector providing collected data to TPSPs for the purpose described herein, you may opt-out by emailing privacy@carsondunlop.com.

If you DO NOT consent to receiving future communications from CD concerning its products and services, you may opt-out by emailing privacy@carsondunlop.com.

17) LEGAL ADVICE

You acknowledge that you have either sought and received, or have had sufficient opportunity to seek and receive, such independent legal advice as you desire in relation to the effect of this Agreement and your legal rights.

18) CLIENT'S AGREEMENT

You understand and agree to be bound by each provision of this Agreement. You hereby confirm that you have the authority to bind any other family members or other interested parties to this Agreement.

If any court declares any provision of this Agreement invalid or unenforceable, the remaining provisions will remain in effect. This Agreement represents the entire agreement between the parties. All prior communications are merged into this Agreement, and there are no terms or conditions other than those set forth herein. No statement or promise of the Inspector shall be binding unless reduced to writing and signed by the Inspector. No change or modification shall be enforceable against any party unless such change or modification is in writing and signed by the parties.



Canadian Association of Home & Property Inspectors

2023 National Standards of Practice

The National Standards of Practice are for home and property inspectors to follow in the performance of their inspections. They are the most widely accepted Canadian home and property inspection Standards in use and address all the home’s major systems and components as listed in this Standard. The National Standards of Practice and Code of Ethics are recognized by many related professionals as the definitive standards for professional performance in the industry.

These National Standards of Practice are being published to inform the public on the nature and scope of visual building inspections performed by home and property inspectors who are members of the Canadian Association of Home & Property Inspectors (CAHPI).

The purpose of the National Standards of Practice is to provide minimum requirements for home and property inspectors regarding both the inspection itself and the inspection report, and to define certain terms relating to the performance of home or property inspections to ensure consistent interpretation.

These standards take into account that a visual inspection of a building does not constitute an evaluation or a verification of compliance with building codes, standards or regulations governing the construction industry or the health and safety industry, or standards and regulations governing insurability.

INDEX	
1.	Introduction 2
2.	Purpose and Scope 2
3.	General Limitations and Exclusions 2
4.	Structural Systems 4
5.	Exterior Systems 4
6.	Roof Systems 4
7.	Plumbing Systems 4
8.	Electrical Systems 4
9.	Heating Systems 5
10.	Fireplaces & Solid Fuel Burning Appliances 5
11.	Air Conditioning Systems 5
12.	Interior Systems 5
13.	Insulation and Vapour Retarders 5
14.	Mechanical and Natural Ventilation Systems 6
	Glossary 6

Any terms not defined in the glossary of this standard will use industry standard terms.

Glossary Note: Italicized words are defined in the Glossary.

1. INTRODUCTION

- 1.1** The Canadian Association of Home & Property Inspectors (CAHPI) is a not-for-profit association. CAHPI strives to promote excellence within the profession and continual improvement of inspection services to the public.

2. PURPOSE AND SCOPE

- 2.1** The purpose of these National Standards of Practice is to establish professional and uniform Standards for home and property inspectors who are members of CAHPI. Home and Property Inspections performed to these National Standards of Practice are intended to provide information regarding the condition of the systems and components of the building as observed at the time of the Inspection.

These National Standards of Practice apply to inspections of part or all of a building for the following building types:

- single-family dwelling, detached, semi-detached or row house
- multi-unit residential building
- residential building held in divided or undivided co-ownership
- residential building occupied in part for a residential occupancy and in part for a commercial occupancy, as long as the latter use does not exceed 40% of the building's total area, excluding the basement.

2.2 THE INSPECTOR SHALL:

A. inspect:

1. *readily-accessible*, visually-observable *installed systems*, and *components* of buildings listed in these National Standards of Practice.

B. report:

1. on those installed *systems* and *components* that, in the professional opinion or judgement of the *inspector*, have a *significant deficiency*, or are near the end of their *service lives*.
2. the implication for the *system* or *component* that has a *significant deficiency* or is near the end of its *service life*.
3. the inspector's recommendations to correct, repair, or refer for further evaluation of the reported deficiency by a qualified specialist.
4. on any *systems* and *components* designated for inspection in these National Standards of Practice which were known to be present at the time of the *Home or Property Inspection* but were not inspected and a reason they were not inspected.

2.3 These National Standards of Practice are not intended to limit inspectors from:

- A. including other inspection services in addition to those required by these National Standards of Practice provided the *inspector* is appropriately qualified to do so.
- B. excluding *systems* and *components* from the inspection if requested by the client or as dictated by circumstances at the time of the inspection.

3. GENERAL LIMITATIONS AND EXCLUSIONS

3.1 GENERAL LIMITATIONS:

- A. Inspections performed in accordance with these National Standards of Practice
 1. are not *technically exhaustive*.
 2. will not identify concealed conditions or latent defects.

3.2 GENERAL EXCLUSIONS:

- A. The *inspector* is not required to perform any action or make any determination unless specifically stated in these National Standards of Practice, except as may be required by lawful authority.

2023 National Standards of Practice. © Copyright 2023 Canadian Association of Home & Property Inspectors. All Rights Reserved.

- B. *Inspectors are NOT required to determine:*
1. condition of *systems* or *components* which are not *readily accessible*.
 2. remaining *service life* of any *system* or *component*.
 3. strength, adequacy, effectiveness, or efficiency of any *system* or *component*.
 4. causes of any condition or deficiency.
 5. methods, materials, or costs of corrections.
 6. future conditions including, but not limited to, failure of *systems* and *components*.
 7. suitability of the property for any use.
 8. compliance with regulatory requirements (codes, regulations, laws, ordinances, etc.).
 9. market value of the property or its marketability.
 10. advisability of the purchase of the property.
 11. presence of potentially hazardous plants, animals or insects including, but not limited to wood destroying organisms, diseases or organisms harmful to humans.
 12. presence of any environmental hazards including, but not limited to toxins, carcinogens, noise, and contaminants in soil, water, and air.
 13. effectiveness of any *system installed* or methods utilized to control or remove suspected hazardous substances.
 14. operating costs of *systems* or *components*.
 15. acoustical properties of any *system* or *component*.
 16. design adequacy with regards to location of the home or property, or the elements to which it is exposed.
- C. *Inspectors are NOT required to offer or perform:*
1. any act or service contrary to law, statute or regulation.
 2. *engineering, architectural* and technical services.
 3. work in any trade or any professional service other than *home or property inspection*.
 4. warranties or guarantees of any kind.
- D. *Inspectors are NOT required to operate:*
1. any *system* or *component* which is *shut down* or otherwise inoperable.
 2. any *system* or *component* which does not respond to *normal operating controls*.
 3. shut-off valves.
- E. *Inspectors are NOT required to enter:*
1. any area which will, in the opinion of the *inspector*, likely be hazardous to the *inspector* or other persons or damage the property or its *systems* or *components*.
 2. spaces which are not *readily accessible*.
- F. *Inspectors are NOT required to inspect:*
1. underground items including, but not limited to, storage tanks or other indications of their presence, whether abandoned or active.
 2. *systems* or *components* which are not *installed*.
 3. *decorative* items.
 4. *systems* or *components* located in areas that are not *readily accessible* in accordance with these National Standards of Practice.
 5. detached buildings.
 6. common elements or common areas in multi-unit housing, such as condominium/strata properties, or cooperative housing when inspecting individual units, including the roof and building envelope.
 7. test and/or operate any fire alarm system, burglar alarm system, automatic sprinkler system or other fire protection equipment, electronic or automated installations, telephone, intercom, cable/ internet systems and any lifting equipment, elevator, freight elevator, wheelchair lift, climbing chair, escalator or others;
 8. pools, *spas* and their associated safety devices.
- G. *Inspectors are NOT required to:*
1. perform any procedure or operation which will, in the opinion of the *inspector*, likely be hazardous to the *inspector* or other persons or damage the property or its *systems* or *components*.
 2. move suspended ceiling tiles, personal property, furniture, equipment, plants, soil, snow, ice, or debris.
 3. *dismantle* any *system* or *component*.

OVERVIEW	ROOFING	EXTERIOR	STRUCTURE	ELECTRICAL	HEATING	COOLING	INSULATION	PLUMBING	INTERIOR
OUR ADVICE	APPENDIX	REFERENCE							

4. STRUCTURAL SYSTEMS

4.1 THE INSPECTOR SHALL:

A. inspect:

1. *structural components* including visible foundation and framing.

B. report:

1. methods used to *inspect* the *crawl space*.
2. methods used to *inspect* the attics.

5. EXTERIOR SYSTEMS

5.1 THE INSPECTOR SHALL:

A. inspect:

1. exterior wall coverings, flashing and trim.
2. all exterior doors.
3. decks, balconies, stairs, porches, and their associated guards and handrails.
4. eaves, soffits, and fascia where visible from the ground level.
5. grading, and surface drainage.
6. walkways, patios, and driveways.
7. retaining walls and fences.
8. attached garages or carports including garage doors and garage door operators.

B. report:

1. the methods used to inspect the exterior walls and their related components.

5.2 THE INSPECTOR IS NOT REQUIRED TO:

A. inspect:

1. screening, shutters, awnings, and similar accessories.
2. geological, geotechnical, or hydrological conditions.
3. *recreational facilities*.
4. detached garages and outbuildings except as required by local authority with jurisdiction.
5. mechanical lifts.
6. seawalls, breakwaters, dikes, and docks.
7. erosion control and earth stabilization measures.

6. ROOF SYSTEMS

6.1 THE INSPECTOR SHALL:

A. inspect:

1. roof coverings.
2. *roof drainage systems*.
3. flashings.
4. skylights, chimneys, and roof penetrations.

B. describe:

1. roof coverings.

C. report:

1. methods used to inspect the roofs.

6.2 THE INSPECTOR IS NOT REQUIRED TO:

A. inspect:

1. antennae and satellite dishes.
2. interiors of flues or chimneys.
3. other *installed* items attached to but not related to the roof systems.

7. PLUMBING SYSTEMS

7.1 THE INSPECTOR SHALL:

A. inspect:

1. interior water supply and distribution *systems* including all fixtures and faucets.
2. drain, waste and vent *systems* including all fixtures.
3. water-heating equipment and associated venting *systems*.
4. fuel storage and distribution *systems*.
5. drainage sumps, sump pumps, and related piping.
6. backflow preventers on supply piping.

B. describe:

1. water supply, distribution, drain, waste, and vent piping materials.
2. water heating equipment including the energy source.
3. location of main water and fuel shut-off valves.

7.2 THE INSPECTOR IS NOT REQUIRED TO:

A. inspect:

1. clothes washing machine connections.
2. wells, well pumps, cisterns, or water storage related equipment.
3. water conditioning *systems*.
4. solar water heating *systems*.
5. fire sprinkler *systems*.
6. private waste disposal *systems*.
7. irrigation *systems*.

B. determine:

1. whether water supply and waste disposal *systems* are public or private.
2. the quantity or quality of the water supply.

C. operate:

1. safety valves or shut-off valves.

8. ELECTRICAL SYSTEMS

8.1 THE INSPECTOR SHALL:

A. inspect:

1. service drop.
2. service entrance conductors, cables, and raceways.
3. service equipment and main disconnects.
4. service grounding.
5. interior components of service panels and sub panels.

OVERVIEW	ROOFING	EXTERIOR	STRUCTURE	ELECTRICAL	HEATING	COOLING	INSULATION	PLUMBING	INTERIOR
OUR ADVICE	APPENDIX	REFERENCE							

6. distribution conductors.
7. overcurrent protection devices.
8. a *representative number* of *installed* lighting fixtures, switches, and receptacles.
9. ground fault circuit interrupters (GFCI).
10. arc fault circuit interrupters (AFCI).
11. smoke alarms.
12. carbon monoxide alarms.

8.2 THE INSPECTOR IS NOT REQUIRED TO:

A. inspect:

1. remote control devices unless the device is the only control device.
2. alarm *systems* and *components*.
3. low voltage wiring, *systems* and *components*.
4. ancillary wiring, *systems* and *components* not a part of the primary electrical power distribution *system*.
5. telecommunication equipment.

B. measure:

1. amperage, voltage, or impedance.

C. operate or test:

1. smoke alarms.
2. carbon monoxide alarms.

9. HEATING SYSTEMS

9.1 THE INSPECTOR SHALL:

A. inspect:

1. *installed* heating equipment.
2. vent systems, flues, and chimneys.
3. fuel storage and distribution *systems*.

9.2 THE INSPECTOR IS NOT REQUIRED TO:

A. inspect:

1. interiors of flues or chimneys.
2. heat exchangers.
3. auxiliary equipment.
4. solar heating *systems*.

B. determine:

1. system adequacy or distribution balance.

10. FIREPLACES AND SOLID FUEL BURNING APPLIANCES

10.1 THE INSPECTOR SHALL:

A. inspect:

1. fireplace and solid fuel burning system components.
2. vent systems and chimneys.

B. describe:

1. fireplaces and solid fuel burning appliances.

10.2 THE INSPECTOR IS NOT REQUIRED TO:

A. inspect:

1. interior of flues or chimneys.

2. screens, doors and dampers.
 3. seals and gaskets.
 4. automatic fuel feed devices.
 5. heat distribution systems whether fan-assisted or convection.
- B. ignite or extinguish fires or pilot lights.
 C. determine draft characteristics.
 D. move fireplace inserts, stoves, or firebox contents.

11. AIR CONDITIONING SYSTEMS

11.1 THE INSPECTOR SHALL:

A. inspect

1. permanently *installed* air conditioning equipment.

11.2 THE INSPECTOR IS NOT REQUIRED TO:

A. inspect

1. portable air conditioners.

B. determine:

1. system adequacy or distribution balance.

12. INTERIOR SYSTEMS

12.1 THE INSPECTOR SHALL:

A. inspect:

1. walls, ceilings, and floors.
2. stairs, guards and handrails.
3. a *representative number* of countertops and *installed* cabinets.
4. a *representative number* of doors and windows.
5. gas proofing of walls, doors and ceilings separating the habitable spaces and the garage.
6. fire separations.

12.2 THE INSPECTOR IS NOT REQUIRED TO:

A. inspect:

1. *decorative* finishes.
2. window treatments.
3. central vacuum *systems*.
4. *household appliances*.
5. *recreational facilities*.

13. INSULATION AND VAPOUR RETARDERS

13.1 THE INSPECTOR SHALL:

A. inspect:

1. insulation and *vapour retarders*.

B. describe:

1. type of insulation materials and *vapour retarders* in unfinished spaces.

13.2 THE INSPECTOR IS NOT REQUIRED TO:

A. disturb:

1. insulation.
2. *vapour retarders*

14. MECHANICAL AND NATURAL VENTILATION SYSTEMS

14.1 THE INSPECTOR SHALL:

A. inspect:

1. ventilation of attics and foundation areas.
2. *mechanical ventilation systems*.
3. the ventilation systems in areas where moisture is generated such as kitchens, bathrooms, laundry rooms.

14.2 THE INSPECTOR IS NOT REQUIRED TO:

B. determine:

1. indoor air quality.
2. system adequacy or distribution balance.

GLOSSARY

Adjacent

Nearest in space or position; immediately adjoining without intervening space.

Alarm Systems

Warning devices, installed or free-standing, including but not limited to; carbon monoxide alarms, flue gas and other spillage alarms, security equipment, ejector pumps and smoke alarms.

Architectural Service

Any practice involving the art and science of building design for construction of any structure or grouping of structures and the use of space within and surrounding the structures or the design for construction, including but not specifically limited to, schematic design, design development, preparation of construction contract documents, and administration of the construction contract, adequacy of design for the location and exposure to the elements.

Automatic Safety Controls

Devices designed and installed to protect *systems* and *components* from unsafe conditions.

Component

A part of a *system*.

Crawl Space

The area within the confines of the foundation and between the ground and the underside of the floor.

Decorative

Ornamental; not required for the operation of *systems* and *components* of a building.

Describe

To *report* a *system* or *component* by its type or other observed, significant characteristics to distinguish it from other *systems* or *components*.

Determine

To find out, or come to a conclusion by investigation.

Dismantle

To take apart or remove any component, device, or piece of equipment that would not be taken apart or removed by a homeowner in the course of normal and routine homeowner maintenance.

Engineering Service

Any professional service or creative work requiring engineering education, training, and experience and the application of special knowledge of the mathematical, physical and engineering sciences to such professional service or creative work as consultation, investigation, evaluation, planning, design and supervision of construction for the purpose of assuring compliance with the specifications and design, in conjunction with structures, buildings, machines, equipment, works or processes.

Functionality

The purpose that something is designed or expected to fulfill.

Further Evaluation

Examination and analysis by a qualified professional, tradesperson or service technician beyond that provided by the *home inspection*.

OVERVIEW

ROOFING

EXTERIOR

STRUCTURE

ELECTRICAL

HEATING

COOLING

INSULATION

PLUMBING

INTERIOR

OUR ADVICE

APPENDIX

REFERENCE

Home and Property Inspection

The process by which an *inspector* visually examines the *readily accessible systems* and *components* of a building in accordance with these National Standards of Practice.

Household Appliances

Kitchen, laundry, and similar appliances, whether *installed* or *freestanding*.

Inspect

To examine *readily accessible systems* and *components* of a building in accordance with these National Standards of Practice, *where applicable* using *normal operating controls* and opening *readily openable access panels*.

Inspector

A person hired to examine any *system* or *component* of a building in accordance with these National Standards of Practice.

Installed

Set up or fixed in position for current use or service.

Mechanical Ventilation Systems

An active or powered air exhaust and/or intake system installed to remove moisture or contaminants from, or introduce fresh air into, the living space.

Normal Operating Controls

Devices such as thermostats, switches or valves intended to be operated by the homeowner.

Operate

To cause to function, turn on, to control the function of a machine, process, or system.

Readily Accessible

Available for visual inspection without requiring moving of personal property, *dismantling*, destructive measures, or any action which will likely involve risk to persons or property.

Readily Openable Access Panel

A panel provided for homeowner inspection and maintenance that is within normal reach, can be removed by one person, and is not sealed in place.

Recreational Facilities

Spas, saunas, steam baths, swimming pools, exercise, entertainment, athletic, playground or other similar equipment and associated accessories.

Report

To communicate in writing.

Representative Number

One *component* per room for multiple similar interior *components* such as windows and electric outlets; one *component* on each side of the building for multiple similar exterior *components*.

Roof Drainage Systems

Components used to carry water off a roof and away from a building.

Sample

A representative portion selected for inspection.

Service Life/Lives

The period during which something continues to function fully as intended.

Shut Down

A state in which a *system* or *component* cannot be operated by *normal operating controls*.

Significant Deficiency

A clearly definable hazard or a clearly definable potential for failure or is unsafe or not functioning.

Solid Fuel Burning Appliances

A hearth and fire chamber or similar prepared place in which a fire may be built, and which is built in conjunction with a chimney; or a listed assembly of a fire chamber, its chimney and related factory-made parts designed for unit assembly without requiring field construction.

Spa

Residential recreational or therapeutic device.

Structural Component

A component that supports non-variable forces or weights (dead loads) and variable forces or weights (live loads).

System

A combination of interacting or interdependent components, assembled to carry out one or more functions.

Technically Exhaustive

An inspection is technically exhaustive when it is done by a specialist who may make extensive use of measurements, instruments, testing, calculations, and other means to develop scientific or engineering findings, conclusions, and recommendations.

Technical Services

Services that involve dismantling, the extensive use of advanced techniques, measurements, instruments, tools, testing, calculations, or other similar methods.

OVERVIEW	ROOFING	EXTERIOR	STRUCTURE	ELECTRICAL	HEATING	COOLING	INSULATION	PLUMBING	INTERIOR
OUR ADVICE	APPENDIX	REFERENCE							

Unsafe

A condition in a *readily accessible, installed system or component* which is judged to be a significant risk of personal injury during normal, day-to-day use. The risk may be due to damage, deterioration, missing or improper installation or a change in accepted residential construction Standards.

Note - In these National Standards of Practice, redundancy in the description of the requirements, limitations and exclusions regarding the scope of the Home and Property Inspection is provided for clarity not emphasis.

Vapour Retarder

Material used in the building envelope to retard the passage of water vapour.

(CAHPI acknowledges The American Society of Home Inspectors®, Inc. (ASHI®) for the use of their Standards of Practice (version January 1, 2000)

Visually Accessible

Able to be viewed by reaching or entering.

(JANUARY 25, 2023 VER.G)

OVERVIEW	ROOFING	EXTERIOR	STRUCTURE	ELECTRICAL	HEATING	COOLING	INSULATION	PLUMBING	INTERIOR
OUR ADVICE	APPENDIX	REFERENCE							



As a Carson Dunlop client, you are entitled to many useful discounts and perks from some of our home service partners.



Woodbridge GTA ClimateCare (\$160 value)

- Get a **FREE** safety inspection and tune-up on your home's heating or cooling systems (your choice)
- Claim your \$160 value tune-up by calling [905-851-7007](tel:905-851-7007) or emailing info@gtacclimatecare.com



Our gift to you - a **\$100 Jiffy gift card***

Jiffy connects homeowners to trusted Pros, delivering instant appointments at pre-set, fair rates. To redeem your gift card, create an account at jiffyondemand.com or via mobile app. Use code **CARSON91472** on your first booking, or enter your code in your Jiffy Profile. ***Where available**

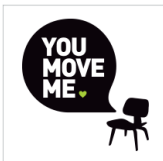

\$100 Gift Card from You Move Me

<https://www.youmoveme.com/ca/save-100-off-moving-services>



\$70 gift card from 1-800-GOT-JUNK?

Carson Dunlop clients receive a \$70 gift card for junk removal services.



David Slack Insurance Brokers

Specializing in older homes, David provides superior, knowledgeable advice and service in a timely manner. [\(800\) 971-1363](tel:800-971-1363) or email david@davidslackinsurance.com

OVERVIEW	ROOFING	EXTERIOR	STRUCTURE	ELECTRICAL	HEATING	COOLING	INSULATION	PLUMBING	INTERIOR
OUR ADVICE	APPENDIX	REFERENCE							



THREE STEPS TO COST-EFFECTIVE HOME FLOOD PROTECTION

Complete these 3 steps to reduce your risk of flooding and lower the cost of cleanup if flooding occurs. For items listed under step 3 check with your municipality about any permit requirements and the availability of flood protection subsidies. **Applicable only in homes with basements*

Step 1: Maintain What You've Got at Least Twice per Year

Do-it-Yourself for \$0

Remove debris from nearest storm drain or ditch & culvert

Clean out eaves troughs

Check for leaks in plumbing, fixtures and appliances

Test your sump pump*

Clean out your backwater valve

Step 2: Complete Simple Upgrades

Do-it-Yourself for Under \$250

Install window well covers (where fire escape requirements permit)*

Extend downspouts and sump discharge pipes at least 2m from foundation

Store valuables and hazardous materials in watertight containers & secure fuel tanks

Remove obstructions to floor drain

Install and maintain flood alarms

Step 3: Complete More Complex Upgrades

Work with a Contractor for Over \$250

Install window wells that sit 10-15cm above ground and upgrade to water resistant windows*

Disconnect downspouts, cap foundation drains and extend downspouts to direct water at least 2m from foundation

Correct grading to direct water at least 2m away from foundation

Install backwater valve

Install backup sump pump and battery*

Note: Not all actions will be applicable to each home. Completing these steps does not guarantee the prevention of flooding.

- OVERVIEW
- ROOFING
- EXTERIOR
- STRUCTURE
- ELECTRICAL
- HEATING
- COOLING
- INSULATION
- PLUMBING
- INTERIOR
- OUR ADVICE
- APPENDIX
- REFERENCE



Basement Flood Protection Checklist

Take these steps to reduce your risk of basement flooding and reduce the cost of cleaning up after a flood. Remember to check with your municipality about the availability of basement flood protection subsidies. Check with your insurer about discounts for taking action to reduce flood risk.

1. Maintain Your Home’s Flood Protection Features at Least Twice Per Year

SPRING FALL

- Remove debris from nearest storm drain
- Clean out eaves troughs
- Test sump pump(s) and backup power source
- Clean out backwater valve
- Maintain plumbing, appliances and fixtures
- Test flood alarms

2. Keep Water Out of Your Basement

- Correct grading to direct water at least 2m away from your foundation
- Extend downspouts and sump discharge pipes to direct water at least 2m away from your foundation or to the nearest drainage swale
- Install window well covers
- Install window wells that are 10-15cm above the ground and are sealed at the foundation
- Install water-resistant basement windows
- Install a backwater valve (work with a plumber and get required permits)

3. Prepare to Remove Any Water from Your Basement as Quickly as Possible

- Remove obstructions to the basement floor drain
- Install a back-up sump pump and power source

4. Protect Personal Belongings in Your Basement

- Store valuables in watertight containers or remove
- Store hazardous materials (paints, chemicals) in watertight containers or remove
- Raise electronics off the floor
- Select removable area rugs and furnishings that have wooden or metal legs

Note: Not all actions will be applicable to each home. Completing these steps does not guarantee the prevention of basement flooding.



For Additional Resources Visit:
www.HomeFloodProtect.ca



THIS CONTRACT LIMITS THE LIABILITY OF THE HOME INSPECTOR AND THE HOME INSPECTION COMPANY.

PLEASE READ CAREFULLY BEFORE ACCEPTING.

The term "Inspector" or "we" as used in this document means, collectively, the home inspector and Carson, Dunlop & Associates Ltd. ("CD"), the home inspection company. The home inspection ("Inspection") is performed in accordance with the Standards of Practice of the Canadian Association of Home and Property Inspectors (the "Standards"). We recommend that you review the Standards before agreeing to the Inspection. To access the Standards, click [CAHPI 2023 National Standards of Practice](#).

1) PURPOSE AND LIMITATIONS

The Inspector's report (the "Report") is an opinion of the present condition of the property based on a visual examination of the readily accessible features of the building.

An Inspector is a generalist, rather than a specialist. The Inspection is a non-invasive performance review, rather than a design review. The Inspector does not perform calculations to determine whether mechanical, electrical, and structural systems, for example, are properly sized. The Inspector will not perform any engineering, architectural, plumbing or electrical services or assessments that require an occupational license.

The Inspector may report on deficiencies or conditions that are normally outside the scope of the Inspection, but this is done as a courtesy and does not change the scope of the Inspection.

If the purpose or limitations are not clear, we encourage you to contact the Inspector to discuss the agreement before accepting and before the inspection.

2) THE INSPECTION IS NOT TECHNICALLY EXHAUSTIVE

The Inspection is a sampling exercise and is not technically exhaustive. While looking for major issues, we typically come across some smaller issues. These may be included in the Report as a courtesy, but not all issues will be identified. Cosmetic and other non-critical items are not part of the Inspection. Establishing the significance of an issue may be beyond the scope of the Inspection. Further evaluation by a specialist may be required at additional cost.

A Technical Audit is a more in-depth, technically exhaustive inspection of the home that provides more information than an Inspection. We have both services available. By accepting and signing this Agreement, you acknowledge that you have chosen an Inspection instead of a Technical Audit.

If you are concerned about any conditions noted in the Report, we strongly recommend that you consult a qualified specialist for a more detailed analysis.

3) THE INSPECTION IS AN OPINION OF THE PRESENT CONDITION OF THE VISIBLE COMPONENTS

The Report is based on the visually observable conditions on the date and time of the Inspection. Not all deficiencies may be apparent due to weather conditions, inoperable systems, inaccessibility, etc. The Inspector cannot predict future conditions.

RLS:00475320.1

An Inspection does NOT include or identify defects that are hidden behind walls, floors, ceilings, storage, furniture, etc. This includes inaccessible elements such as, but not limited to, wiring, heating, cooling, structure, plumbing and insulation. Inspectors do not remove wall coverings (including wallpaper), lift flooring (including carpet), or move storage or furniture.

Intermittent problems may not be visible on an Inspection because they only happen under certain circumstances. For example, the Inspector may not discover leaks that occur only during certain weather conditions.

Representative sampling is used for components where there are several similar items. This includes, but is not limited to, roofing, siding, masonry, caulking, windows, interior doors, electrical wiring, receptacles, switches, ducts and pipes, insulation and air/vapor barriers, and floor, wall, and ceiling surfaces.

4) THIS IS NOT A CODE-COMPLIANCE INSPECTION

Inspectors do NOT determine whether the property complies with past or present building codes, electrical codes, fuel codes, fire codes, regulations, laws, by-laws, ordinances, or other regulatory requirements. Codes change regularly, and most homes do not comply with current codes.

5) THE INSPECTION DOES NOT INCLUDE HAZARDOUS MATERIALS

The Inspection does NOT address building materials that are suspected of posing a risk to health such as phenol-formaldehyde and urea-formaldehyde based insulation, fiberglass insulation and vermiculite insulation. Inspectors do NOT identify asbestos in roofing, siding, wall, ceiling or floor finishes, insulation, fireproofing, etc. Inspectors do NOT look for lead or other toxic metals. Environmental consultants should be consulted independently, at additional cost, should concerns exist.

The Inspection does not address environmental hazards such as the past use of insecticides, fungicides, herbicides, pesticides or termite treatments.

6) THE INSPECTION DOES NOT ADDRESS MOULD AND THE AIR QUALITY IN A BUILDING

The Inspection does NOT address irritants, pollutants, contaminants, or toxic materials in or around the building. This includes, for example, spores, fungus, mould, or mildew.

You should note that whenever there is water damage, there is a possibility that mould or mildew may be present, unseen behind a wall, floor, or ceiling.

If anyone in your home suffers from allergies or heightened sensitivity to quality of air, or if there are water penetration issues noted in the Report, we strongly recommend that you consult a qualified environmental consultant who can test for toxic materials, mould and allergens at an additional cost.

7) THE INSPECTION DOES NOT INCLUDE BURIED TANKS

Inspectors do NOT look for, and are not responsible for identifying, fuel oil, septic or gasoline tanks that may be buried on the property. If there are fuel oil or other storage tanks on the property, you may be responsible for their removal and the safe disposal of any contaminated soil. If you suspect there is a buried tank, we strongly recommend that you retain a qualified Environmental Consultant, at an additional cost, to investigate further.

RLS:00475320.1

OVERVIEW

ROOFING

EXTERIOR

STRUCTURE

ELECTRICAL

HEATING

COOLING

INSULATION

PLUMBING

INTERIOR

OUR ADVICE

APPENDIX

REFERENCE

8) CANCELLATION FEE

If the Inspection is cancelled within 24 hours of the appointment time, a cancellation fee of 50% of the fee will apply.

9) THERMAL IMAGING (If included with this Inspection)

The use of a thermal imager by your Inspector (which you can purchase for an extra cost) is for the purpose of screening for potential water issues. While the use of this equipment improves the odds of detecting a moisture issue, it is not a guarantee, as numerous conditions can mask the thermal signature of moisture. Thermal imaging will not detect all moisture issues behind walls, ceilings, or furniture. Additionally, water leakage is often intermittent, and cannot be detected when not present.

10) MOULD ASSESSMENT (If included with this Inspection)

The services provided in this optional assessment (which you can purchase for an extra cost) include a visual inspection for signs of water intrusion and mould growth. Moisture readings will be collected. Two indoor air samples and one outdoor reference sample will be collected. Should visible mould growth be identified, one surface sample will be collected. The results of the sample and investigation will be summarized in a written Report.

The mould assessment will not be able to detect or identify all mould that may be present in the home, including that which is hidden behind walls, floors, ceilings, storage, or furniture.

11) REPORT IS FOR OUR CLIENT ONLY

The Report is for the exclusive use of the client named herein and their real estate agent if applicable and will not be released to others without the client's consent. No use of, or reliance on, the Report or any information contained in the Report by any other party is intended. The client agrees that the Report will not be shared or distributed to third parties, except to prospective buyers of the property in the case of a pre-listing inspection.

NOTE: If you do not want your real estate agent to receive a copy of the report, please let us know at 416-964-9415 or inspection@carsondunlop.com.

12) NOT A GUARANTEE, WARRANTY, OR INSURANCE POLICY

The Inspection and Report are NOT a guarantee, warranty, or an insurance policy on the condition, future use, operability, habitability or suitability of the home or its components.

Given the limitations to the visual Inspection, the Inspector is neither responsible nor liable for the non-discovery of any patent or latent defects, or other conditions which may occur or may become evident after the date and time of the Inspection.

13) TIME TO INVESTIGATE

The Inspector will have no liability for any claim or complaint if conditions have been disturbed, altered, repaired, replaced, or otherwise changed before the Inspector has had reasonable time to investigate.

RLS:00475320.1

14) LIMIT OF LIABILITY/INDEMNITY

By executing this Agreement, you expressly agree that the TOTAL CUMULATIVE LIABILITY OF THE INSPECTOR AND CD FOR ANY DAMAGES ARISING OUT OF ANY ACTS OR OMISSIONS WITH RESPECT TO THE INSPECTOR'S INSPECTION AND REPORT, FOR ANY CAUSE OF ACTION WHATSOEVER, WHETHER IN CONTRACT OR TORT (INCLUDING NEGLIGENCE), IS LIMITED TO A REFUND OF THE FEES THAT YOU HAVE BEEN CHARGED FOR THIS INSPECTION OR \$1,000, WHICHEVER IS GREATER.

You agree to indemnify and hold the Inspector, CD and its directors, officers, employees, agents, affiliates and consultants harmless from and against any and all claims, demands, liabilities, judgements, losses and expenses, including legal fees and expenses, brought against or involving the Inspector that relate to or arise out of the Inspection or the Report whether indirect, consequential, punitive or special losses, damages, or loss of profits.

You agree that any claim for negligence, breach of contract or otherwise relating to the Inspection or the Report will be made in writing and reported to the Inspector within 10 business days of discovery. Further, you agree to allow the Inspector the opportunity to re-inspect the claimed discrepancy, except for an emergency condition, before anyone repairs, replaces, alters or modifies the claimed discrepancy. You understand and agree that any failure to notify the Inspector as stated above shall constitute a waiver of all claims that you may have against the Inspector.

This limit of liability clause may be altered at the discretion and agreement of the Inspector and the client, but any agreement must be in writing and appended to this Agreement.

15) TIME PERIOD

You acknowledge and agree that the timeframe for commencement of legal proceedings by you against the Inspector for damages suffered by you as a result of alleged errors, omissions, breaches of contract and/or negligence by the Inspector shall not be later than one (1) year from the date of the Inspection.

16) PRIVACY/USE OF PERSONAL INFORMATION

The Inspector confirms their commitment to collect, store and use your personal information only in accordance with the terms of the CD's Privacy Policy. A copy of this document may be accessed at <https://www.carsondunlop.com/privacy/>. You are strongly encouraged to review this document before signing this Agreement and providing your personal information to the Inspector and CD.

The Inspector may collect data which will primarily consist of information relating to the visual inspection conducted, but may also consist of other data relating to the property inspected, client and/or client representative personal and contact information, and demographic data. The Inspector may use the collected data to perform analysis, improve business processes, improve the CD inspection experience, and obtain feedback from clients and client representatives. The Inspector confirms that collection and use of this data and certain personal information is for the following purposes:

- To provide you with information regarding CD products, services and benefits that you request or other products, services and benefits which may interest you; and

- To identify trends and patterns related to the use of goods and services in the home inspection and construction industries and to provide information on those trends and patterns to our customers and others.

In addition, the Inspector may provide collected data to third-party service providers ("TPSPs") to offer value-added services to clients, as described in this Agreement. The Inspector may provide aggregated collected data, individual collected data and/or collected personal information (including name, property address, email addresses, phone numbers, appliance information and property data) to third parties. Other than interaction with TPSPs, aggregated data, individual collected data and/or collected personal information, the Inspector will not sell or rent the collected data to anyone, or share the collected data with any third party except as necessary to fulfill client requests.

By executing this Agreement, you confirm that you expressly consent to the collection and use of data by the Inspector as described herein and in CD's Privacy Policy.

If you DO NOT consent to the Inspector providing collected data to TPSPs for the purpose described herein, you may opt-out by emailing privacy@carsondunlop.com.

If you DO NOT consent to receiving future communications from CD concerning its products and services, you may opt-out by emailing privacy@carsondunlop.com.

17) LEGAL ADVICE

You acknowledge that you have either sought and received, or have had sufficient opportunity to seek and receive, such independent legal advice as you desire in relation to the effect of this Agreement and your legal rights.

18) CLIENT'S AGREEMENT

You understand and agree to be bound by each provision of this Agreement. You hereby confirm that you have the authority to bind any other family members or other interested parties to this Agreement.

If any court declares any provision of this Agreement invalid or unenforceable, the remaining provisions will remain in effect. This Agreement represents the entire agreement between the parties. All prior communications are merged into this Agreement, and there are no terms or conditions other than those set forth herein. No statement or promise of the Inspector shall be binding unless reduced to writing and signed by the Inspector. No change or modification shall be enforceable against any party unless such change or modification is in writing and signed by the parties.



Canadian Association of Home & Property Inspectors

2023 National Standards of Practice

The National Standards of Practice are for home and property inspectors to follow in the performance of their inspections. They are the most widely accepted Canadian home and property inspection Standards in use and address all the home’s major systems and components as listed in this Standard. The National Standards of Practice and Code of Ethics are recognized by many related professionals as the definitive standards for professional performance in the industry.

These National Standards of Practice are being published to inform the public on the nature and scope of visual building inspections performed by home and property inspectors who are members of the Canadian Association of Home & Property Inspectors (CAHPI).

The purpose of the National Standards of Practice is to provide minimum requirements for home and property inspectors regarding both the inspection itself and the inspection report, and to define certain terms relating to the performance of home or property inspections to ensure consistent interpretation.

These standards take into account that a visual inspection of a building does not constitute an evaluation or a verification of compliance with building codes, standards or regulations governing the construction industry or the health and safety industry, or standards and regulations governing insurability.

INDEX	
1.	Introduction 2
2.	Purpose and Scope 2
3.	General Limitations and Exclusions 2
4.	Structural Systems 4
5.	Exterior Systems 4
6.	Roof Systems 4
7.	Plumbing Systems 4
8.	Electrical Systems 4
9.	Heating Systems 5
10.	Fireplaces & Solid Fuel Burning Appliances 5
11.	Air Conditioning Systems 5
12.	Interior Systems 5
13.	Insulation and Vapour Retarders 5
14.	Mechanical and Natural Ventilation Systems 6
	Glossary 6

Any terms not defined in the glossary of this standard will use industry standard terms.

Glossary Note: Italicized words are defined in the Glossary.

1. INTRODUCTION

- 1.1** The Canadian Association of Home & Property Inspectors (CAHPI) is a not-for-profit association. CAHPI strives to promote excellence within the profession and continual improvement of inspection services to the public.

2. PURPOSE AND SCOPE

- 2.1** The purpose of these National Standards of Practice is to establish professional and uniform Standards for home and property inspectors who are members of CAHPI. Home and Property Inspections performed to these National Standards of Practice are intended to provide information regarding the condition of the systems and components of the building as observed at the time of the Inspection.

These National Standards of Practice apply to inspections of part or all of a building for the following building types:

- single-family dwelling, detached, semi-detached or row house
- multi-unit residential building
- residential building held in divided or undivided co-ownership
- residential building occupied in part for a residential occupancy and in part for a commercial occupancy, as long as the latter use does not exceed 40% of the building's total area, excluding the basement.

2.2 THE INSPECTOR SHALL:

A. inspect:

1. *readily-accessible*, visually-observable *installed systems*, and *components* of buildings listed in these National Standards of Practice.

B. report:

1. on those installed *systems* and *components* that, in the professional opinion or judgement of the *inspector*, have a *significant deficiency*, or are near the end of their *service lives*.
2. the implication for the *system* or *component* that has a *significant deficiency* or is near the end of its *service life*.
3. the inspector's recommendations to correct, repair, or refer for further evaluation of the reported deficiency by a qualified specialist.
4. on any *systems* and *components* designated for inspection in these National Standards of Practice which were known to be present at the time of the *Home or Property Inspection* but were not inspected and a reason they were not inspected.

2.3 These National Standards of Practice are not intended to limit inspectors from:

- A. including other inspection services in addition to those required by these National Standards of Practice provided the *inspector* is appropriately qualified to do so.
- B. excluding *systems* and *components* from the inspection if requested by the client or as dictated by circumstances at the time of the inspection.

3. GENERAL LIMITATIONS AND EXCLUSIONS

3.1 GENERAL LIMITATIONS:

- A. Inspections performed in accordance with these National Standards of Practice
 1. are not *technically exhaustive*.
 2. will not identify concealed conditions or latent defects.

3.2 GENERAL EXCLUSIONS:

- A. The *inspector* is not required to perform any action or make any determination unless specifically stated in these National Standards of Practice, except as may be required by lawful authority.

2023 National Standards of Practice. © Copyright 2023 Canadian Association of Home & Property Inspectors. All Rights Reserved.

- B.** *Inspectors* are NOT required to determine:
1. condition of *systems* or *components* which are not *readily accessible*.
 2. remaining *service life* of any *system* or *component*.
 3. strength, adequacy, effectiveness, or efficiency of any *system* or *component*.
 4. causes of any condition or deficiency.
 5. methods, materials, or costs of corrections.
 6. future conditions including, but not limited to, failure of *systems* and *components*.
 7. suitability of the property for any use.
 8. compliance with regulatory requirements (codes, regulations, laws, ordinances, etc.).
 9. market value of the property or its marketability.
 10. advisability of the purchase of the property.
 11. presence of potentially hazardous plants, animals or insects including, but not limited to wood destroying organisms, diseases or organisms harmful to humans.
 12. presence of any environmental hazards including, but not limited to toxins, carcinogens, noise, and contaminants in soil, water, and air.
 13. effectiveness of any *system installed* or methods utilized to control or remove suspected hazardous substances.
 14. operating costs of *systems* or *components*.
 15. acoustical properties of any *system* or *component*.
 16. design adequacy with regards to location of the home or property, or the elements to which it is exposed.
- C.** *Inspectors* are NOT required to offer or perform:
1. any act or service contrary to law, statute or regulation.
 2. *engineering, architectural* and technical services.
 3. work in any trade or any professional service other than *home or property inspection*.
 4. warranties or guarantees of any kind.
- D.** *Inspectors* are NOT required to operate:
1. any *system* or *component* which is *shut down* or otherwise inoperable.
 2. any *system* or *component* which does not respond to *normal operating controls*.
 3. shut-off valves.
- E.** *Inspectors* are NOT required to enter:
1. any area which will, in the opinion of the *inspector*, likely be hazardous to the *inspector* or other persons or damage the property or its *systems* or *components*.
 2. spaces which are not *readily accessible*.
- F.** *Inspectors* are NOT required to *inspect*:
1. underground items including, but not limited to, storage tanks or other indications of their presence, whether abandoned or active.
 2. *systems* or *components* which are not *installed*.
 3. *decorative* items.
 4. *systems* or *components* located in areas that are not *readily accessible* in accordance with these National Standards of Practice.
 5. detached buildings.
 6. common elements or common areas in multi-unit housing, such as condominium/strata properties, or cooperative housing when inspecting individual units, including the roof and building envelope.
 7. test and/or operate any fire alarm system, burglar alarm system, automatic sprinkler system or other fire protection equipment, electronic or automated installations, telephone, intercom, cable/ internet systems and any lifting equipment, elevator, freight elevator, wheelchair lift, climbing chair, escalator or others;
 8. pools, *spas* and their associated safety devices.
- G.** *Inspectors* are NOT required to:
1. perform any procedure or operation which will, in the opinion of the *inspector*, likely be hazardous to the *inspector* or other persons or damage the property or its *systems* or *components*.
 2. move suspended ceiling tiles, personal property, furniture, equipment, plants, soil, snow, ice, or debris.
 3. *dismantle* any *system* or *component*.

OVERVIEW	ROOFING	EXTERIOR	STRUCTURE	ELECTRICAL	HEATING	COOLING	INSULATION	PLUMBING	INTERIOR
OUR ADVICE	APPENDIX	REFERENCE							

4. STRUCTURAL SYSTEMS

4.1 THE INSPECTOR SHALL:

A. inspect:

1. *structural components* including visible foundation and framing.

B. report:

1. methods used to *inspect* the *crawl space*.
2. methods used to *inspect* the attics.

5. EXTERIOR SYSTEMS

5.1 THE INSPECTOR SHALL:

A. inspect:

1. exterior wall coverings, flashing and trim.
2. all exterior doors.
3. decks, balconies, stairs, porches, and their associated guards and handrails.
4. eaves, soffits, and fascia where visible from the ground level.
5. grading, and surface drainage.
6. walkways, patios, and driveways.
7. retaining walls and fences.
8. attached garages or carports including garage doors and garage door operators.

B. report:

1. the methods used to inspect the exterior walls and their related components.

5.2 THE INSPECTOR IS NOT REQUIRED TO:

A. inspect:

1. screening, shutters, awnings, and similar accessories.
2. geological, geotechnical, or hydrological conditions.
3. *recreational facilities*.
4. detached garages and outbuildings except as required by local authority with jurisdiction.
5. mechanical lifts.
6. seawalls, breakwaters, dikes, and docks.
7. erosion control and earth stabilization measures.

6. ROOF SYSTEMS

6.1 THE INSPECTOR SHALL:

A. inspect:

1. roof coverings.
2. *roof drainage systems*.
3. flashings.
4. skylights, chimneys, and roof penetrations.

B. describe:

1. roof coverings.

C. report:

1. methods used to inspect the roofs.

6.2 THE INSPECTOR IS NOT REQUIRED TO:

A. inspect:

1. antennae and satellite dishes.
2. interiors of flues or chimneys.
3. other *installed* items attached to but not related to the roof systems.

7. PLUMBING SYSTEMS

7.1 THE INSPECTOR SHALL:

A. inspect:

1. interior water supply and distribution *systems* including all fixtures and faucets.
2. drain, waste and vent *systems* including all fixtures.
3. water-heating equipment and associated venting *systems*.
4. fuel storage and distribution *systems*.
5. drainage sumps, sump pumps, and related piping.
6. backflow preventers on supply piping.

B. describe:

1. water supply, distribution, drain, waste, and vent piping materials.
2. water heating equipment including the energy source.
3. location of main water and fuel shut-off valves.

7.2 THE INSPECTOR IS NOT REQUIRED TO:

A. inspect:

1. clothes washing machine connections.
2. wells, well pumps, cisterns, or water storage related equipment.
3. water conditioning *systems*.
4. solar water heating *systems*.
5. fire sprinkler *systems*.
6. private waste disposal *systems*.
7. irrigation *systems*.

B. determine:

1. whether water supply and waste disposal *systems* are public or private.
2. the quantity or quality of the water supply.

C. operate:

1. safety valves or shut-off valves.

8. ELECTRICAL SYSTEMS

8.1 THE INSPECTOR SHALL:

A. inspect:

1. service drop.
2. service entrance conductors, cables, and raceways.
3. service equipment and main disconnects.
4. service grounding.
5. interior components of service panels and sub panels.

OVERVIEW	ROOFING	EXTERIOR	STRUCTURE	ELECTRICAL	HEATING	COOLING	INSULATION	PLUMBING	INTERIOR
OUR ADVICE	APPENDIX	REFERENCE							

6. distribution conductors.
7. overcurrent protection devices.
8. a *representative number* of *installed* lighting fixtures, switches, and receptacles.
9. ground fault circuit interrupters (GFCI).
10. arc fault circuit interrupters (AFCI).
11. smoke alarms.
12. carbon monoxide alarms.

8.2 THE INSPECTOR IS NOT REQUIRED TO:

- A. inspect:**
1. remote control devices unless the device is the only control device.
 2. alarm *systems* and *components*.
 3. low voltage wiring, *systems* and *components*.
 4. ancillary wiring, *systems* and *components* not a part of the primary electrical power distribution *system*.
 5. telecommunication equipment.
- B. measure:**
1. amperage, voltage, or impedance.
- C. operate or test:**
1. smoke alarms.
 2. carbon monoxide alarms.

9. HEATING SYSTEMS

9.1 THE INSPECTOR SHALL:

- A. inspect:**
1. *installed* heating equipment.
 2. vent systems, flues, and chimneys.
 3. fuel storage and distribution *systems*.

9.2 THE INSPECTOR IS NOT REQUIRED TO:

- A. inspect:**
1. interiors of flues or chimneys.
 2. heat exchangers.
 3. auxiliary equipment.
 4. solar heating *systems*.
- B. determine:**
1. system adequacy or distribution balance.

10. FIREPLACES AND SOLID FUEL BURNING APPLIANCES

10.1 THE INSPECTOR SHALL:

- A. inspect:**
1. fireplace and solid fuel burning system components.
 2. vent systems and chimneys.
- B. describe:**
1. fireplaces and solid fuel burning appliances.

10.2 THE INSPECTOR IS NOT REQUIRED TO:

- A. inspect:**
1. interior of flues or chimneys.

2. screens, doors and dampers.
 3. seals and gaskets.
 4. automatic fuel feed devices.
 5. heat distribution systems whether fan-assisted or convection.
- B. ignite or extinguish fires or pilot lights.**
- C. determine draft characteristics.**
- D. move fireplace inserts, stoves, or firebox contents.**

11. AIR CONDITIONING SYSTEMS

11.1 THE INSPECTOR SHALL:

- A. inspect**
1. permanently *installed* air conditioning equipment.

11.2 THE INSPECTOR IS NOT REQUIRED TO:

- A. inspect**
1. portable air conditioners.
- B. determine:**
1. system adequacy or distribution balance.

12. INTERIOR SYSTEMS

12.1 THE INSPECTOR SHALL:

- A. inspect:**
1. walls, ceilings, and floors.
 2. stairs, guards and handrails.
 3. a *representative number* of countertops and *installed* cabinets.
 4. a *representative number* of doors and windows.
 5. gas proofing of walls, doors and ceilings separating the habitable spaces and the garage.
 6. fire separations.

12.2 THE INSPECTOR IS NOT REQUIRED TO:

- A. inspect:**
1. *decorative* finishes.
 2. window treatments.
 3. central vacuum *systems*.
 4. *household appliances*.
 5. *recreational facilities*.

13. INSULATION AND VAPOUR RETARDERS

13.1 THE INSPECTOR SHALL:

- A. inspect:**
1. insulation and *vapour retarders*.
- B. describe:**
1. type of insulation materials and *vapour retarders* in unfinished spaces.

13.2 THE INSPECTOR IS NOT REQUIRED TO:

- A. disturb:**
1. insulation.
 2. *vapour retarders*

14. MECHANICAL AND NATURAL VENTILATION SYSTEMS

14.1 THE INSPECTOR SHALL:

A. inspect:

1. ventilation of attics and foundation areas.
2. *mechanical ventilation systems*.
3. the ventilation systems in areas where moisture is generated such as kitchens, bathrooms, laundry rooms.

14.2 THE INSPECTOR IS NOT REQUIRED TO:

B. determine:

1. indoor air quality.
2. system adequacy or distribution balance.

GLOSSARY

Adjacent

Nearest in space or position; immediately adjoining without intervening space.

Alarm Systems

Warning devices, installed or free-standing, including but not limited to; carbon monoxide alarms, flue gas and other spillage alarms, security equipment, ejector pumps and smoke alarms.

Architectural Service

Any practice involving the art and science of building design for construction of any structure or grouping of structures and the use of space within and surrounding the structures or the design for construction, including but not specifically limited to, schematic design, design development, preparation of construction contract documents, and administration of the construction contract, adequacy of design for the location and exposure to the elements.

Automatic Safety Controls

Devices designed and installed to protect *systems* and *components* from unsafe conditions.

Component

A part of a *system*.

Crawl Space

The area within the confines of the foundation and between the ground and the underside of the floor.

Decorative

Ornamental; not required for the operation of *systems* and *components* of a building.

Describe

To *report* a *system* or *component* by its type or other observed, significant characteristics to distinguish it from other *systems* or *components*.

Determine

To find out, or come to a conclusion by investigation.

Dismantle

To take apart or remove any component, device, or piece of equipment that would not be taken apart or removed by a homeowner in the course of normal and routine homeowner maintenance.

Engineering Service

Any professional service or creative work requiring engineering education, training, and experience and the application of special knowledge of the mathematical, physical and engineering sciences to such professional service or creative work as consultation, investigation, evaluation, planning, design and supervision of construction for the purpose of assuring compliance with the specifications and design, in conjunction with structures, buildings, machines, equipment, works or processes.

Functionality

The purpose that something is designed or expected to fulfill.

Further Evaluation

Examination and analysis by a qualified professional, tradesperson or service technician beyond that provided by the *home inspection*.

Home and Property Inspection

The process by which an *inspector* visually examines the *readily accessible systems* and *components* of a building in accordance with these National Standards of Practice.

Household Appliances

Kitchen, laundry, and similar appliances, whether *installed* or *freestanding*.

Inspect

To examine *readily accessible systems* and *components* of a building in accordance with these National Standards of Practice, *where applicable* using *normal operating controls* and opening *readily openable access panels*.

Inspector

A person hired to examine any *system* or *component* of a building in accordance with these National Standards of Practice.

Installed

Set up or fixed in position for current use or service.

Mechanical Ventilation Systems

An active or powered air exhaust and/or intake system installed to remove moisture or contaminants from, or introduce fresh air into, the living space.

Normal Operating Controls

Devices such as thermostats, switches or valves intended to be operated by the homeowner.

Operate

To cause to function, turn on, to control the function of a machine, process, or system.

Readily Accessible

Available for visual inspection without requiring moving of personal property, *dismantling*, destructive measures, or any action which will likely involve risk to persons or property.

Readily Openable Access Panel

A panel provided for homeowner inspection and maintenance that is within normal reach, can be removed by one person, and is not sealed in place.

Recreational Facilities

Spas, saunas, steam baths, swimming pools, exercise, entertainment, athletic, playground or other similar equipment and associated accessories.

Report

To communicate in writing.

Representative Number

One *component* per room for multiple similar interior *components* such as windows and electric outlets; one *component* on each side of the building for multiple similar exterior *components*.

Roof Drainage Systems

Components used to carry water off a roof and away from a building.

Sample

A representative portion selected for inspection.

Service Life/Lives

The period during which something continues to function fully as intended.

Shut Down

A state in which a *system* or *component* cannot be operated by *normal operating controls*.

Significant Deficiency

A clearly definable hazard or a clearly definable potential for failure or is unsafe or not functioning.

Solid Fuel Burning Appliances

A hearth and fire chamber or similar prepared place in which a fire may be built, and which is built in conjunction with a chimney; or a listed assembly of a fire chamber, its chimney and related factory-made parts designed for unit assembly without requiring field construction.

Spa

Residential recreational or therapeutic device.

Structural Component

A component that supports non-variable forces or weights (dead loads) and variable forces or weights (live loads).

System

A combination of interacting or interdependent components, assembled to carry out one or more functions.

Technically Exhaustive

An inspection is technically exhaustive when it is done by a specialist who may make extensive use of measurements, instruments, testing, calculations, and other means to develop scientific or engineering findings, conclusions, and recommendations.

Technical Services

Services that involve dismantling, the extensive use of advanced techniques, measurements, instruments, tools, testing, calculations, or other similar methods.

OVERVIEW	ROOFING	EXTERIOR	STRUCTURE	ELECTRICAL	HEATING	COOLING	INSULATION	PLUMBING	INTERIOR
OUR ADVICE	APPENDIX	REFERENCE							

Unsafe

A condition in a *readily accessible, installed system or component* which is judged to be a significant risk of personal injury during normal, day-to-day use. The risk may be due to damage, deterioration, missing or improper installation or a change in accepted residential construction Standards.

Note - In these National Standards of Practice, redundancy in the description of the requirements, limitations and exclusions regarding the scope of the Home and Property Inspection is provided for clarity not emphasis.

Vapour Retarder

Material used in the building envelope to retard the passage of water vapour.

(CAHPI acknowledges The American Society of Home Inspectors®, Inc. (ASHI®) for the use of their Standards of Practice (version January 1, 2000)

Visually Accessible

Able to be viewed by reaching or entering.

(JANUARY 25, 2023 VER.G)

The links below connect you to a series of documents that will help you understand your home and how it works. These are in addition to links attached to specific items in the report.

Click on any link to read about that system.

» 01. ROOFING, FLASHINGS AND CHIMNEYS

» 02. EXTERIOR

» 03. STRUCTURE

» 04. ELECTRICAL

» 05. HEATING

» 06. COOLING/HEAT PUMPS

» 07. INSULATION

» 08. PLUMBING

» 09. INTERIOR

» 10. APPLIANCES

» 11. LIFE CYCLES AND COSTS

» 12. SUPPLEMENTARY

Asbestos

Radon

Urea Formaldehyde Foam Insulation (UFFI)

Lead

Carbon Monoxide

Mold

Household Pests

Termites and Carpenter Ants

» 13. HOME SET-UP AND MAINTENANCE

» 14. MORE ABOUT HOME INSPECTIONS

